



Feb

25 Cents
1930

Radio-Craft

for the
Professional-Serviceman-Radiotrician

HUGO GERNSBACK Editor

Radio Engineering Co



WALTER
EDWARD
BLYTHE

Hertz

Men who have made Radio: Heinrich Hertz

R. T. I.

R. T. I. QUALIFIES YOU TO MAKE MONEY AND ITS SERVICE KEEPS YOU UP-TO-THE-MINUTE ON THE NEWEST DEVELOPMENTS IN RADIO, TELEVISION, AND TALKING PICTURES

R. T. I.

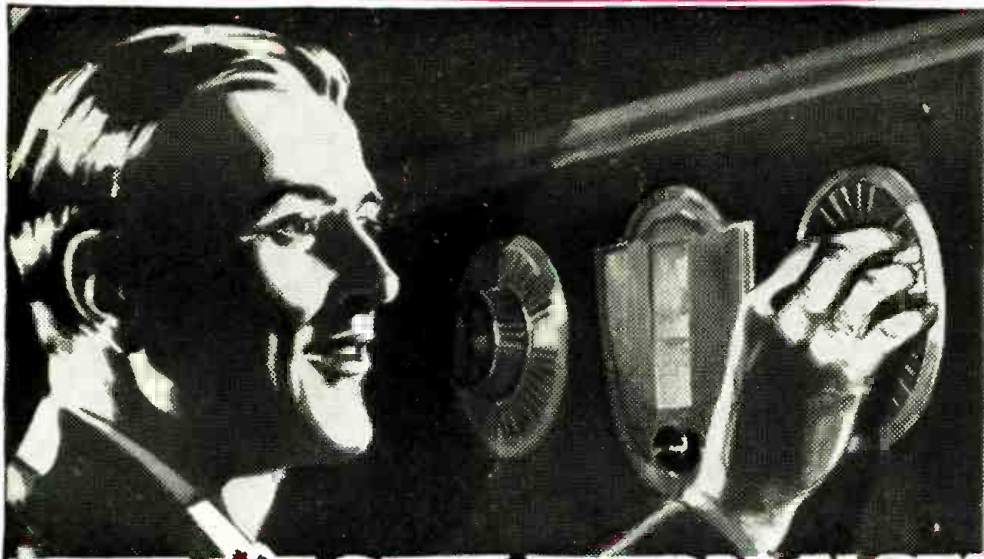

THE RIGHT TURN NOW BRINGS BIG-MONEY JOBS

and lifetime success in the newest and fastest growing industry in the world

RADIO FOREMEN
Large radio factory has opening for several foremen thoroughly experienced on chassis assembly lines. Will make interesting proposition to right men.
ADDRESS—G Y 138, Tribune.

RADIO FINAL SET TESTER
Splendid opportunity for young man with thorough knowledge of radio, to handle final set test in production line.
GALVEN MFG. CORP., 847 W. Harrison-st.

RADIO SERVICE MAN.
Must be capable of servicing and installing any make of radio. Apply Mon. or Tues. between 9-11 a. m.
642 N. Michigan-av.

RADIO TESTERS
and balancers, experienced on A. C. sets; unusual pay for men who qualify. Call Smith, Grovehill 0600, or apply Silver-Marshall, Inc., 5401 W. 65th-st.

Salary Raised 33 1/3% Since Enrolling
Am now radio service manager for N. H. Knight Supply Co.—Earl P. Gordon, 618 E. 6th St., Oklahoma City, Okla.

Earned \$500 Extra in Two Months
In spare-time work — Pigeon you all the credit — J. Nofsinger, R. I. Box 37, Greenville, Ky.

\$60 a Week—Now a \$10 Raise
Repaired sets others fell down on — promoted to foreman — Fred E. Klemann, Box 8, Lisle, Ill.

Big R. T. I. Book FREE Now—Use the Coupon!
All you have to do is fill in the coupon and we will mail you, post paid, our wonderful book "Tune In On Big Pay." There is no other book like it. You will be startled, like thousands of others, with its thrilling pages — its amazing photographs — overwhelming evidence of the incomparable money-making opportunities for you in Radio — RIGHT NOW! Send for it immediately.

RADIO & TELEVISION INSTITUTE
Dept. 772
4806 St. Anthony Court, Chicago

RADIO

The great new infant Radio industry continually outgrows the supply of trained men for its needs. Therefore, R. T. I. is seeking hundreds of earnest, ambitious men to train to fill the jobs that lead to \$2500—\$3500—\$5000 a year and up. Spare-time work too is waiting everywhere—thousands of dollars to be made easily, quickly, in every part of the country.

TELEVISION

Now comes Television out of the experimental radio laboratory on the verge of another vast demand for men who are qualified to expand it and the R. T. I. "3 in 1" Home Training in Radio, Television and Talking Pictures offers you big opportunity in this magic new field.

TALKING PICTURES

The vast sweep of Talking Pictures through the larger cities is about to cover the country, creating more and more jobs that must be filled by men with such training as R. T. I. gives

R. T. I. Famous "3 in 1" Home Training Radio—Television—Talking Pictures

Qualifies you easily, quickly, and surely for Big-Pay Jobs in RADIO or either of its new and fast-growing sister industries—TELEVISION and the TALKING PICTURES. Your age or previous experience do not matter.

NOW IS THE TIME!

Never before in the history of the civilized world has there been such opportunity for ambitious men. These great industries—the "Big 3"—offer Big-Money Jobs—money-making without limit—all available to men and boys who are far-seeing enough "to get in on the ground floor"—right now, —and R. T. I. makes it easy for you to get in. Send for the Big free R. T. I. book.



F. H. SCHNELL

Let F. H. Schnell and the R. T. I. Advisory Board Help You

Mr. Schnell, Chief of the R. T. I. Staff, is one of the ablest and best known radio men in America. He has twenty years of radio experience. He was the first to establish two way amateur communication with Europe. Former Traffic Manager of American Radio Relay League, Lieutenant Commander of the U. S. Naval Reserve. Inventor and designer of Radio apparatus. Consultant Engineer to large Radio manufacturers.

Assisting him is the R. T. I. Advisory Board, composed of men prominent in the Radio industry—manufacturing, broadcasting, engineering and servicing. All these men know Radio and will help you succeed in their field.

START AT HOME Quick Money NOW!

To meet the great demand for trained men from the new Radio, Television and Talking Picture field, R. T. I. with the help of its connections in the industry, has built up an easy, learn-at-home practical plan that will prepare you for these good jobs. You use fine testing and working outfits and learn by work sheets and the invaluable R. T. I. Job Tickets prepared by men who know. It's easy because clearly explained so you can do it—yet it is practical, scientific, and makes you an expert. R. T. I. starts you making money right at home and keeps stepping you up and up in the Big-Pay class.

The Facts Will Thrill You

You cannot possibly imagine the astounding present development of Radio, Television and Talking Pictures—their limitless future expansion—the big number of money-making jobs—spare-time profits—right now and rushing on bigger and bigger. The actual pictures and facts from all sources all are in the R. T. I. Free Book.



RADIO & TELEVISION INSTITUTE
Dept. 772 4806 St. Anthony Court, Chicago

Send me Free and prepaid your BIG BOOK "Tune In On Big Pay" and full details of your three-in-one Home Training (without obligating me in any way).

Name.....
Address.....
City..... State.....

R. T. I. R. T. I. TRAINS YOU AT HOME FOR A GOOD JOB OR A PROFITABLE PART TIME OR FULL TIME BUSINESS OF YOUR OWN

4 of the 40 Easy Ways to Make \$3.00 an Hour

In Your Spare Time in RADIO

Below
are a few of
the reports
from those now
cashing in on the
"40 Easy Ways"

THE four plans shown are but a sample of the many ways in which our members are making \$3.00 an hour upwards, spare time and full time, from the day they join the Association. If you want to get into Radio, have a business of your own, make \$50 to \$75 weekly in your spare time, investigate the opportunities offered the inexperienced, ambitious man by the Association.

Our Members Earning Thousands of Dollars Every Week

The Association assists men to cash in on Radio. It makes past experience unnecessary. As a member of the Association you are trained in a quick, easy, practical way to install, service, repair, build and rebuild sets—given sure-fire money-making plans developed by us—helped to secure a position by our Employment Department. You earn while you learn, while you prepare yourself for a big-pay Radio position.

The Association will enable you to buy parts at wholesale, start in business without capital, help you get your share of the \$600,000,000 spent annually for Radio. As a result of the Association, men all over the country are opening stores, increasing their pay, passing licensed operator examinations, landing big-pay positions with Radio makers.



Mail Coupon Today for the FREE HANDBOOK

It is not only chock-full of absorbing information about Radio, but it shows you how easily you can increase your income in your spare time. Mailing the coupon can mean \$50 to \$75 a week more for you.

Radio Training Association of America
4513 Ravenswood Avenue Dept. RCA 2 Chicago, Illinois



Clears \$3,000.00 Frank J. Deutch, Pa.—“Since joining the Association I have cleared nearly \$3,000.00. It is almost impossible for a young fellow to fail, no matter how little education he has, if he will follow your easy ways of making money.”

\$1,100.00 in 6 Weeks J. R. Allen, Calif.—“Have done over \$1,100.00 worth of business in the last 6 weeks. Next month I am going to open up a store of my own. I never knew that money could come so fast and easy.”

\$25.00 a Week Spare Time N. J. Friedrich, N. Y.—“I have averaged \$25.00 a week for the last 7 months even though I am not a graduate but just learning.”

Training Lands Him Job R. C. Kirk, N. C.—“Your training has been very valuable to me. I landed a job with the big department store out here a few weeks ago because I had my membership card with me. There were a large bunch of applications ahead of me.”

ACT NOW If You Wish NO-COST Membership

For a limited time we will give to the ambitious man a No-Cost Membership which need not—should not—cost you a cent. For the sake of making more money now, and having a better position in the future, mail coupon below *now*. You'll always be glad you did.

Radio Training Association of America
Dept. RCA-2 4513 Ravenswood Ave., Chicago, Ill.
Gentlemen: Please send me by return mail full details of your Special No-Cost Membership Plan, and also a copy of your Radio Handbook.

Name _____
Address _____
City _____ State _____

H. GERNSBACK, President
 S. GERNSBACK, Treasurer
 J. M. HERZBERG, Vice-President
 I. S. MANHEIMER, Secretary

R. D. WASHBURNE,
 Technical Editor



HUGO GERNSBACK, Editor-in-Chief

JOHN F. RIDER,
 Editor Service Dept.

C. P. MASON,
 Associate Editor

VOLUME I
 NUMBER 8

Contents of This Issue

FEBRUARY
 1930

	PAGE		PAGE
FRENZIED RADIO.....By Hugo Gernsback	358	SOLVING AUTOMOBILE RADIO PROBLEMS, By M. J. Sheedy	380
LEAVES FROM SERVICE MEN'S NOTEBOOKS, By RADIO-CRAFT Readers	360	THE NEW JENKINS RADIOVISOR, By D. E. Replogle	382
COMPLETENESS IN RADIO-TESTING EQUIPMENT.....By H. G. Cisin	362	THE CATHODE-RAY TELEVISION RECEIVER....	384
CAUSES AND CURE OF RADIO INTERFERENCE, By F. R. Bristow	364	AIRPLANE RADIO CREATES MANY JOBS.....	385
OPERATING NOTES FOR SERVICE MEN, By Bertram M. Freed	368	A "COMPOSITE" SHORT-WAVE RECEIVER, By Robert Neil Auble	386
A COMPLETE PORTABLE RADIO TESTING LABORATORY (Part II).....By George C. Miller	369	THE HAMMARLUND SHORT-WAVE ADAPTER RECEIVER.....By Lewis Winner	387
RADIO SERVICE DATA SHEETS.....	372	SHORT-WAVE STATIONS OF THE WORLD.....	388
THE SERVICE MAN'S OPEN FORUM.....By Himself	374	NEW RADIO DEVICES FOR SHIP AND HOME....	389
OPPORTUNITIES FOR SERVICE—AN ANNOUNCEMENT	374	THE RADIO DANCERS.....	390
MEN WHO HAVE MADE RADIO— HEINRICH HERTZ	375	A MODERNISTIC LOUD SPEAKER, By Frank C. White	390
NATIONAL LIST OF RADIO SERVICE MEN ENROLLMENT BLANK	375	THE COOPERATIVE RADIO LABORATORY, By David Grimes	391
MODERN SOUND PROJECTION....By Richard Carman	376	\$100.00 IN GOLD FOR A SLOGAN FOR "RADIO-CRAFT"	392
GLOSSARY OF SOUND PROJECTION TECHNICAL TERMS	378	THE RADIO CRAFTSMAN'S OWN PAGE.....	393
		"RADIO-CRAFT" KINKS	394
		INFORMATION BUREAU	396
		"RADIO-CRAFT" SLOGAN COUPON.....	403

In Forthcoming Issues

THE NEW LOFTIN-WHITE DIRECT-COUPLED AMPLIFIER. An astonishingly efficient circuit with a minimum of parts and tubes, which has just been announced by these well-known engineers.

THE EFFECTIVE USE OF BY-PASS CONDENSERS AND RESISTORS. By P. H. Greeley. The author gives reasons for differing from general rule-of-thumb practice in construction, and shows what is necessary for efficient filtering.

"B" POWER FROM A 6-VOLT STORAGE BATTERY. By L. B. Robbins. This ingenious experimenter describes the construction of an inexpensive converter for receiver operation away from standard A.C. supplies.

TROUBLE-SHOOTING IN "B" POWER UNITS. Outline for the systematic diagnosis of receiver trouble due to improper plate and biasing voltages in socket-operated sets.

AND MANY OTHER PRACTICAL AND CONSTRUCTIONAL ARTICLES.

RADIO-CRAFT is published monthly, on the fifth of the month preceding that of date; its subscription price is \$2.50 per year. (In Canada and foreign countries, \$3.00 a year to cover additional postage.) Entered at the postoffice at Mt. Morris, Ill., as second-class matter under the act of March 3, 1879. Title registered U. S. Patent Office. Trademarks and copyrights by permission of Gernsback Publications, Inc., 98 Park Place, New York City.

Text and illustrations of this magazine are copyright and must not be reproduced without permission of the copyright owners. We are also agents for SCIENCE WONDER STORIES, AIR WONDER STORIES, SCIENTIFIC DETECTIVE MONTHLY and SCIENCE WONDER QUARTERLY. Subscriptions to these magazines may be taken in combination with RADIO-CRAFT at reduced Club rates. Write for information.

Copyright 1930, GERNSBACK PUBLICATIONS, INC.

Published by
TECHNI-CRAFT PUBLISHING CORPORATION

Publication Office: 404 No. Wesley Ave., Mount Morris, Illinois

Editorial and Advertising Offices
 96-98 Park Place, New York City

Western Advertising Office
 737 North Michigan Avenue, Chicago, Ill.

L. F. McCLURE, Western Advertising Representative

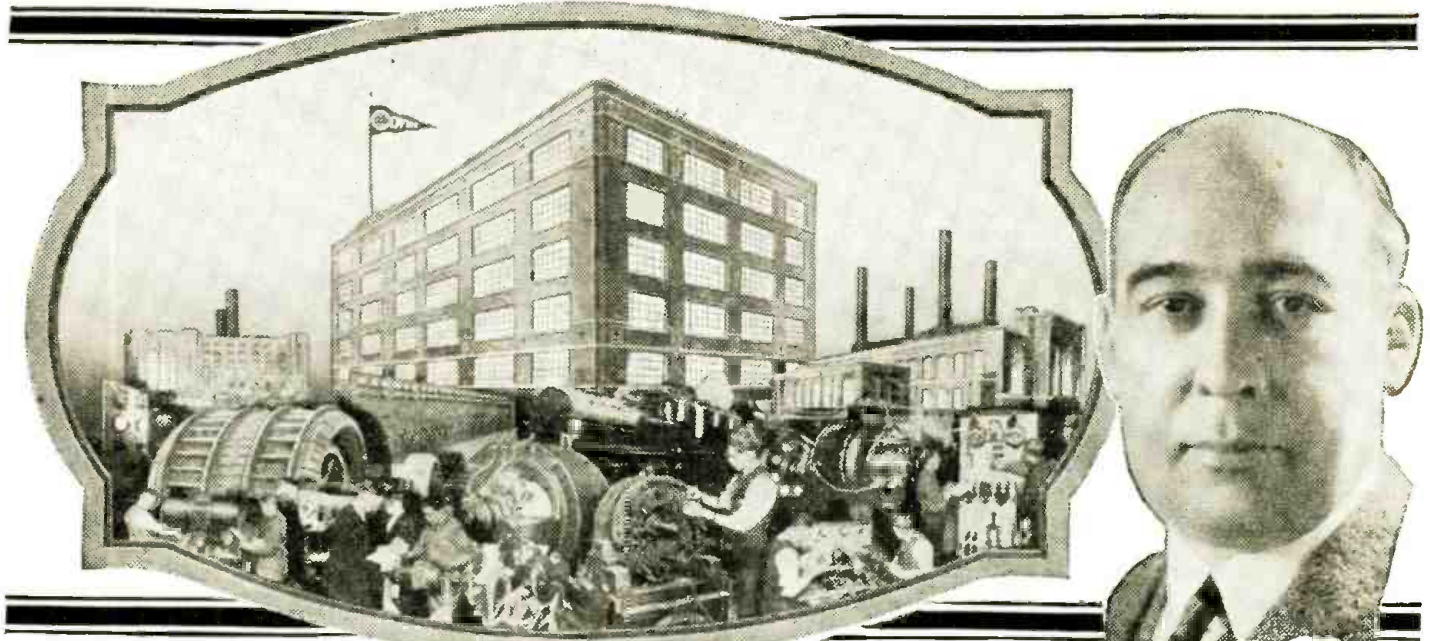

H. C. LEWIS, President

"I Will Train You To Get Into ELECTRICITY In 12 Weeks IN THE GREAT COYNE SHOPS on Real Electrical Machinery

Don't Waste Your Life in a Dull Hopeless Job

Don't spend your life waiting for \$5 raises in a dull, hopeless job. Now . . . and forever . . . say good-bye to 25 and 35 dollars a week. Let me show you how to qualify for jobs leading to salaries of \$50, \$60 and up, a week, in Electricity—NOT by correspondence, but by an amazing way to teach, that makes you a practical expert in 90 days! Getting into Electricity is far easier than you imagine! Act now, today!

Lack of Experience Bars No One

I don't care if you can't tell the difference between a battery and an air brake. Any number of students enter my school knowing no more about electricity than an infant. And yet they graduate and go right out in the field and get electrical jobs leading to big pay.

You Don't Have to Have an Advanced Education

That's the beauty of my method of teaching. It isn't what you know—it's how you are taught that counts. My method of teaching enables you to catch on instantly even though you have only had a common school education without the use of dry books. You don't need advanced education to understand electricity the way I teach it. Just think—you can learn in 90 days. Don't let lack of advanced education worry you.

I Don't Care If You Are 16 Years Old or 40

Electricity gives everybody the same wonderful opportunity. Don't worry about your age. Plenty of men who never succeeded until late in life. This may be just the field you were cut out for. No matter what your age is, or how long it has been since you studied, my method of teaching will prove fascinating and easy to you.

Earn While You Learn

We maintain a real employment service. If you should need part time work, I'll assist you in getting it. If you will just write and tell me your circumstances. In that way many earn while learning. Many of my students pay all their living expenses through part time jobs secured by Coyne.

My Course Includes Training In *Airplane-Electricity*



Not a Correspondence School
COYNE Electrical SCHOOL

H. C. LEWIS, Pres., Dept. 20-95 —Established 1899
500 S. Paulina Street, Chicago

Don't Worry About a Job

Coyne training settles the job question for life. Clyde F. Hart got a position as electrician with the Great Western Railroad at over \$100.00 a week two weeks after graduation. That's not unusual. We can point to Coyne men making up to \$600 a month. Coyne men get positions which lead to salaries of \$50.00, \$60.00 and up a week. You can go into radio, battery or automotive electrical business for yourself and make from \$3000 a year up.

No Books—No Lessons

You work on real live electrical machinery, building real batteries, winding real armatures, operating real motors, dynamos and generators, wiring real houses, etc., etc.—here in this world famous parent school, with its hundreds of thousands of dollars worth of new up-to-date electrical equipment.

Prepare for Jobs Like These—

Coyne men have the advantages of getting positions which lead to those that are listed below. Our free employment bureau gives you lifetime employment service.
Armature Expert—\$50 a Week and up.
Substation Operator—\$65 a Week. Inventor—Unlimited.
Auto Electrician—\$60 a Week and up.
Maintenance Engineer—\$60 a Week and up.
Service Station Owner—\$60 a Week and up.
Radio Expert—\$60 a Week and up.

New \$2,000,000 School

We are now in our new, fireproof, modern home wherein is installed thousands of dollars worth of the newest and most modern electrical equipment of all kinds. We now have a larger amount of floor space devoted to the exclusive teaching of practical electricity. Every comfort and convenience has been arranged to make you happy and contented during your training.

Electricity the Greatest of All Industries

Electricity is THE FIELD. It is one of the youngest. Every day sees an increase in its use. It holds the greatest future. The young man of today who gets into Electricity lays the cornerstone for lasting success—prosperity. Nearly every large building now needs trained Electrical men for maintenance. Every hotel, theatre, station—in fact Practical men are in demand everywhere—all the time.

Thorough Training that Results in Big Pay

My training is so thorough that you will be able to step out and get a job leading to big pay. Hundreds of Coyne graduates testify as to the thoroughness of my course and that if it hadn't been for this thoroughness, they never would have been able to have held their jobs. It's the wonderful, practical, learn-by-doing method which gives Coyne students such a thorough training.

Fascinating Method of Learning

Maybe you don't think this method of training isn't fascinating. The instructor shows you how to do job No. 1. Then you do it. Then he shows you how to do job No. 2. Then you do it. After while you're building real batteries that generate real juice; you wind real armatures that actually work and you do complete house wiring jobs. And all this time you'll find that it's so interesting you won't even realize that you are in school.

Lifetime Employment Service

My lifetime employment service not only helps you after you graduate, but from then on, throughout life, you are always welcome to call upon us for further employment service.

Every Possible Kind of Assistance

My organization is so thorough that you get every possible kind of assistance. We secure a clean room for you at the lowest rates. The welfare department looks after your comfort. We help you to get part time employment. We give entertainments for you. We help you to get a job when you graduate. We keep in touch with you, giving you the advantage of our entire staff should you run across knotty problems and need assistance.

My Big Book FREE!

Coyne is your one great chance to get into electricity. Every obstacle is removed. This school is 30 years old—Coyne training is tested—proven beyond all doubt—endorsed by many large electrical concerns. You can find out everything absolutely free. Simply mail the coupon and let me send you the big, free Coyne book of 150 photographs . . . facts . . . jobs . . . salaries . . . opportunities. Tells you how many earn expenses while training and how we assist our graduates in the field. This does not obligate you. So act at once. Just mail coupon.

Send for Free Book!

Mr. H. C. Lewis, Pres.
COYNE ELECTRICAL SCHOOL, Dept. 20-95
500 S. Paulina St., Chicago, Ill.

Dear Mr. Lewis: Without obligation send me your big free catalog and all details of Free Employment Service, Radio, Aviation Electricity and Automotive Courses that are included and how you will help me "earn while learning."

Name _____
Address _____
City _____ State _____

Not a Correspondence School but An Institution To Which You Come for Practical Training on Real Electrical Machinery

Thousands of Positions Open Right Now

at
Salaries Ranging

UP to \$200⁰⁰ per WEEK

for MOTION PICTURE SOUND Engineers

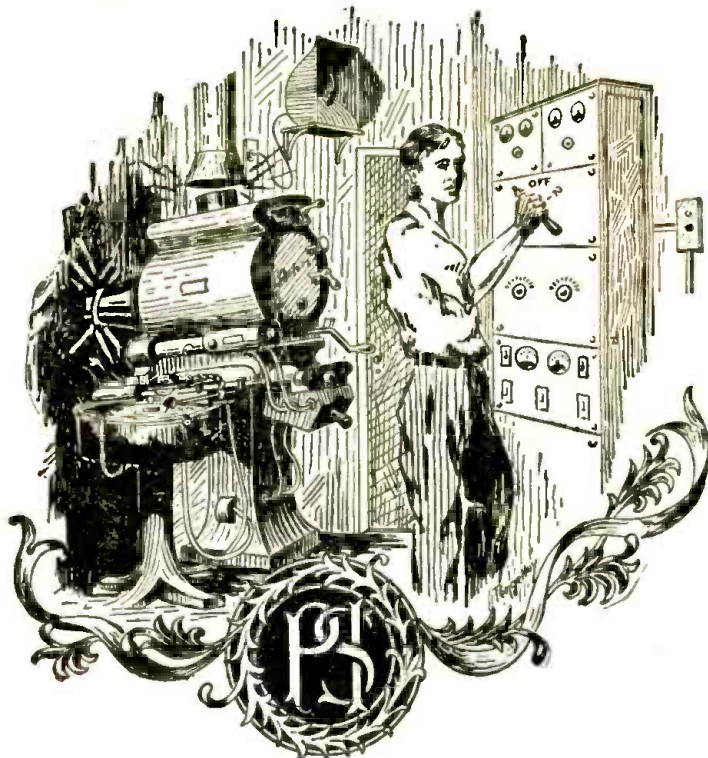

WE are in contact with chain theatres and manufacturers of Sound equipment who desire the services of competent sound men as engineers, projectionists, installation and service men. Our employment department will assist you in making a profitable connection free of charge.

GUARANTEE

Our guarantee insures you that if you enroll as one of our students and take advantage of the many opportunities that your membership entitles you to your increased income will pay the tuition of the course many times. We unconditionally guarantee that if for any reason you are dissatisfied (you being the judge) we will refund every cent you have paid.

Due to the fact that radio and sound are so closely allied, men with radio experience are the most adaptable.

POLICY

Our course on Sound Projection which is prepared by the most eminent authorities on Electrical Acoustics will qualify you for a Profession whose place in the engineering world is second to none. All of the available knowledge of the art and the underlying fundamental principles of sound is given to you in an everyday, plain-talk language, as well as two weeks' practical training in the operation, servicing and installation of Sound Equipment.

DEMAND

In the 20,000 theatres throughout the United States and Canada,

which now employ approximately 50,000 projectionists, it is estimated that a very small per cent of this number are qualified to fill the position as Sound operators. Many thousands of new men will have to be taken into this field as fast as the many thousand unwired theatres are wired for sound as the additions of sound doubles the number of operators required. This condition will create many thousands of positions at salaries up to \$200.00 per week.

The tuition for these courses is very reasonable and is payable in easy installments as you study. Also you have the added convenience of studying at home in your spare time. Fill out and mail the coupon below today for special scholarship proposition.

Mail Coupon for Free Information

PROJECTIONIST SOUND INSTITUTE

"The Authority"
EASTON, PENNA.

PROJECTIONIST SOUND INSTITUTE, EASTON, PENNA.		RC-2
Gentlemen: Please send me, by return mail, full details of your Special Scholarship Proposition on Sound Projection.		
Name.....		
Address.....		
City.....State.....		

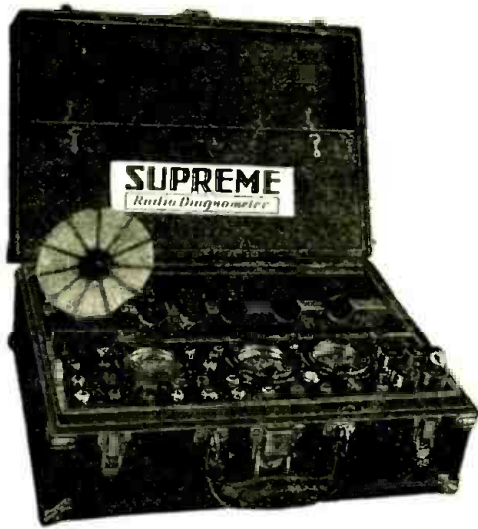

"Supreme" Features

The Supreme oscillation test gives the only dependable test on tubes; tubes tested under actual operating conditions.

The Diagonometer tests all tubes, including screen grid.

Tests both plates of 80 type rectifier tubes; provides bias emission tests on tubes.

All tubes tested independent of radio.

Locates unbalanced secondaries.

Reads both positive or negative cathode bias.

Provides D. C. continuity test without batteries.

Furnishes modulated signal for testing synchronizing, neutralizing, etc.

Aligning of condensers by Thermo-couple meter or A. C. meter.

Neutralizing with tubes used in the set.

Tests gain of audio amplifiers.

3 precision meters; one 4 scale D. C. Voltmeter 0/750/250/100/10 volts, resistance 1000 ohms per volt. One 4 scale A. C. Voltmeter 0/750/150/16/4 volts. One 3 scale Mil-ammeter 0/125/25 mills. 0/2—1/2 amps.

External connection to all apparatus.

Universal analyzer plug.

Thermo-couple meter for varied uses.

Measures resistances in three ranges. 150 to 30,000 ohms (calibration curve furnished) 10—200 ohms .1 to 25 ohms.

Makes all analysis readings.

Screen grid socket analysis without producing oscillation.

Measures capacity of condensers .1 mfd to 9 mfd.

Tests charger output by meter.

Bridges open stages of audio for tests.

Contains 500,000 ohm variable resistor, 30 ohm rheostat and .001 mfd, .002 mfd and 1 mfd condensers for testing.

Detects shorted variable condensers without disconnecting r.f. coil.

Provides low resistance measurement for rosin joints.

Provides simultaneous plate current and plate voltage readings and the customary readings of A. C. and D. C. filament voltage, grid voltage, cathode bias, screen grid voltage, line voltage, etc.

The laboratory test panel is equipped with a variable condenser for varying the frequency of the oscillator.

Provides many other tests, readings and functions.

Most good distributors stock the Supreme. If yours cannot supply you, address, for full information, without obligation,

SUPREME INSTRUMENTS
CORPORATION
353 Supreme Bldg.
GREENWOOD, MISS.

... Speed ... Accuracy... Skill

in trouble shooting

"AMAZING!" That's the way radio technical men speak of the SUPREME DIAGNOMETER. Its numerous remarkable qualities have brought the complete facilities of the laboratory to the home of the set-owner—adding speed and accuracy to the skill of the service-man. No other device approaches it in flexibility, completeness and range. Set testers check only 29%-40% efficient in comparison with its capacity. Comes in handy carrying case providing compartments for all tools and spare tubes, or at the option of the purchaser, in an even smaller case, for the service-man who does not wish to carry tools and tubes in same unit.

and, now, the most practical laboratory test panel

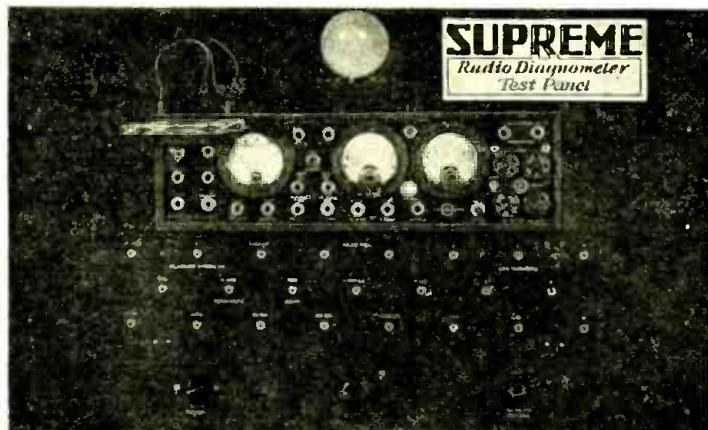

In keeping with SUPREME standards, unquestionably the most advanced test panel ever produced. Of heavy, reinforced Bakelite, it adds to the trim workmanlike appearance of laboratory or shop and assures sturdy service. Makes the DIAGNOMETER a dual purpose instrument—shop or portable service—instantly disconnectable.

SUPREME

Radio Diagonometer

conceivable
Makes every test on any Radio Set-

Frenzied Radio

By Hugo Gernsback

A SITUATION which calls for plain talk at this time has developed in radio. For a long time it has been known, in professional radio circles, that there is something rotten in "Radiodom," but it was thought best to keep quiet about it, rather than embarrass the radio industry by washing its linen in public.

But the situation which has arisen of late makes it necessary for radio set manufacturers to come to their senses, if radio is to survive.

Talking very plainly and to the point, the situation is this: The majority of radio set manufacturers today make sets only "to be sold" and, apparently, do not give a tinker's damn what happens afterwards. Such a thing as giving *real* service is unheard of and, as a rule, the policy of "the public be damned" is pursued by practically all set manufacturers today.

The economic reason for this, again, is apparently very simple. A radio set produced by a first-class manufacturer, with good equipment and under good supervision, is probably good for ten years; and here is the crux of the whole matter. A radio set does not wear out like an automobile, for instance. Without extensive replacements, an automobile lasts, at most, two or three years; then the owner usually trades it in and gets a new car. The best customers of the motor car manufacturer are the owners of cars. With a radio set, the situation is different. A radio set lasts for a long time; there is practically nothing to wear out and, usually, the only reason why a set owner gets a new receiver is that he wishes a more up-to-date one.

We started out with battery sets, which became almost obsolete in 1928; and the set manufacturers promptly found a bonanza in the popular rush for A.C. sets. Last season, screen-grid sets were the mode; but evidently 1928's A.C. set customers were fairly well satisfied, for most of them still retain their 1928 models, and the percentage who have traded them in for 1929 screen-grid receivers is more or less negligible.

The manufacturers toolled up for a tremendous production in 1929, and there was an unfortunate overproduction which, according to one radio trade periodical, amounted to the tremendous figure of 900,000 radio sets in 1929.

But, as we said before, the set manufacturer today, pursuing his purely selfish policy, must sell sets—must sell more, every year, to satisfy his stockholders—or Wall Street, which amounts to the same thing.

The set manufacturer is not at all interested to see that a set is properly serviced, once it is installed, for the simple reason that, every time one of his sets is serviced and put into condition, it causes a customer to remain satisfied, possibly for another year or more, and the latter certainly will not be in the market for a new set.

So what does the manufacturer do? He makes the list price of his set so high that his dealer can take back an old set from a customer, and allow him on it a small amount toward the purchase of a new set. But, within six months, Mr. Public finds out that he has been stung again; for, lo and behold, the same set for which he paid, let us say, \$200.00, now sells for \$50.00, or even less. But it is fair to state here that there are a few set manufacturers who do not reduce their prices; they probably do not overproduce, either.

The evils arising from such malpractices are patent. Recently New York City witnessed the sad spectacle of one large radio chain store which destroyed by fire hundreds of "trade-in" radio sets. The reason? You see, a man who does not already own a radio can journey to Cortlandt Street, in New York City, and buy a good set for \$2.00 or \$3.00. This, then, he takes to the large radio store—and gets an "allowance" of \$25.00 if he buys a new \$165.00 screen-grid "Interplanarian."

So the chain store, to discourage this sort of thing, now intends to destroy all "trade-in" sets; so that they cannot come back like the proverbial cat! Damned clever, these

Radio Chinese! Curing one evil by burning up another one! Great idea, if it could only be made to work—even more efficient than perpetual motion!

RADIO-CRAFT has on file hundreds of letters from Service Men, all over the country, complaining bitterly that co-operation, of any kind, is unobtainable from practically all radio set manufacturers. Letters asking for information on their sets remain unanswered, or the information is given that only "accredited" dealers can get this information.

The "accredited" dealer, however, is in the same boat as the set manufacturer; for he also is not too anxious to really service a set and put it into shape, lest it lose him a sale. It is, however, to his interest to send out a "set butcher" who masquerades as a "service man," and to put the set *out of order*; so that the victim must buy a new set. A good racket while it lasts!

The honest radio dealer and the honest Service Man, who make their living by putting sets in good order and repairing them to the satisfaction of the community, are constantly working at a disadvantage; because they can expect no real help from the set manufacturer. For this reason, the Service Man must rely upon technical publications, such as RADIO-CRAFT and others, to get the necessary information to take care of his customers. In doing this, he naturally performs a great service, not only to the man whose set he repairs successfully, but to the manufacturer of the set as well; although the latter does not give a hoot about it.

It stands to reason that the owner of a set, who has to sell it for five or ten per cent. of its original cost, after he had it for a year or less, is certainly not going to shout its praises from the roof tops; he will be careful, if he has any sense, not to buy one of that make again. But, if a Service Man puts his receiver into good shape again, the layman owner at least does not blame his troubles on the set manufacturer; he thinks something went wrong with the set from natural causes; and, at some later date, he may buy a new model of the same make he had before.

Is all this of any interest to the set manufacturer? Perish the thought! When the Service Man wants information, the set manufacturer will almost never give it; or, if he does (as one famous Eastern set manufacturer does) he charges the service man \$1.00 for an instruction book *which is not complete* and does not give all the information on every model this manufacturer has marketed.

Or take the case of a famous Midwestern set manufacturer who offered to repair one of his recent sets (which, by the way, had only a burnt-out power pack) for the modest sum of \$27.00! Yet a new set of the same vintage, brought out by the same manufacturer, can be had on the open market today for much less money than \$27.00.

Small wonder, then, that the radio set industry is in its present deplorable shape; with practically all the larger radio factories closed down for the time being, tremendous stocks of unsold sets on hand, bankruptcy of a number of radio set manufacturers, and grief all along the line.

It took the majority of radio set manufacturers, with perhaps one or two exceptions, five or six years to wake up and support the industry that was getting them all the business; by that, I mean the broadcast stations. Only during the last year have set manufacturers deemed it wise to seek good will by broadcasting.

It will probably take the industry another five years to learn that it will pay them to take the Service Man into their confidence, and to talk to him in his own language. It is an interesting sidelight that at the present time the radio set industry is out only to catch new suckers in the shape of new customers. If there is any manufacturer who is giving real service to the public who have bought his sets, RADIO-CRAFT will be the first to shout his name from the housetops; and we invite any radio set manufacturer to supply us with evidence to this effect.



My NEW Book is ready for You

**IF you're in Radio now
spare time or full time -
it will show you how
my improved training
can help you make
still more money**



J. E. SMITH, Pres.
NATIONAL RADIO INSTITUTE

**If you're not in Radio /
this book will show you how
you can get in quickly !**

Radio's amazing growth is opening hundreds of fine jobs every year, in broadcasting stations, with Radio dealers, jobbers, manufacturers. Shipping companies offer you many chances to travel all over the world without expense and make good money besides. There are almost unlimited opportunities for a profitable spare time or full time Radio business of your own. My graduates have jumped from \$25, \$35 and \$40 a week to \$50 a week, \$60 a week, \$75 a week and \$100 a week. My book proves this.

I will train you at home in your spare time

Hold your job—I will train you inexpensively in your spare time. I'll give you practical Radio experience with my 50-50 method—one-half from Lesson Texts and one-half from practical home experiments with Eight Outfits of Radio parts that I furnish. I will refund your money if you are not satisfied with my Lessons and Instruction Service when you finish.

I will show you how to make \$10 to \$30 a week in spare time while learning

The day you enroll I'll show you how to do ten jobs common in most every neighborhood. I'll show you how to repair and service all makes of sets and many other jobs. I'll give you the plans and ideas that are making \$200 to \$1,000 for my students while they are taking my course.

**Find out what Radio offers you.
Get my new book**

My book gives you the facts. Tells you where the good Radio jobs are, what they pay, how you can fit yourself right at home in your spare time for a good job in Radio. Tells you about the many extra services and material that the National Radio Institute gives its students and graduates. It shows you what others who have taken the N.R.I. course have done; what they think of it. Get the facts. There's no obligation.

J. E. SMITH, President
NATIONAL RADIO INSTITUTE
Dept. OBY Washington, D. C.

**Before you do anything else
Get the dope on my new...**

Eight Outfits of Radio Parts for a home experimental laboratory covering screen grid, A. C., and many other features in the latest sets.

Service Sheets and Service Manuals giving up-to-date and authentic information on servicing different models and makes of sets.

Work Sheets and Job Sheets which show you how to make extra money in your spare time while taking my course.

Improved Lesson Texts covering thoroughly all branches of Radio.

Instruction material on Talking Movies, both the Vitaphone and Photophone systems.

Training in Television and home experiments in Television reception.

These are only a few improvements. My book, "Rich Rewards in Radio" tells you all about 18 features of my course as I give it today.

Have you read my new book giving an outline of National Radio Institute's training in Radio? If you haven't, send for a copy today. No matter what kind of a job you may have in the Radio industry now, unless you are at or near the top, I believe my training can help you forge ahead—make still more money. However, I'll let you decide that for yourself—just let me show you what I have to offer. Many others in Radio—amateurs, spare time and full time service men, Radio dealers, fans—have found the way to more profits and more money through my course.

See what I offer those who are now or want to be service men

While my course trains you for all branches of Radio—I am giving extensive, thorough, and complete information on servicing different models and makes of A. C. and Screen Grid Sets. Atwater Kent models, Crosley, Zenith, Majestic, Stewart-Warner, Radiola, Eveready and many other makes of sets are covered. This information is of special help—of real money-making value—to those who are now service men or who want to be expert service men. This part of my training, however, is only one of 18 outstanding features that I am offering men and young men who want to get good jobs in Radio—or who are in Radio and want to advance themselves. Even though you may have received information on my course before, unless you have gotten my new book as pictured above, write to me again—see how N.R.I. has grown with Radio's growth and how N.R.I. Radio training has grown and improved too. Organized in 1914, it took the lead then in Radio training and it has kept that lead ever since. This course is not new or untried. Hundreds of men owe their success and larger incomes to N.R.I.

CLIP AND MAIL THIS Coupon DO IT TODAY

J. E. SMITH, President,
National Radio Institute, Dept. OBY,
Washington, D. C.

Dear Mr. Smith:—Send me your book, "Rich Rewards in Radio." I want to see what N.R.I. offers.

Name

Address

City..... State.....

Are you doing Radio work now?.....

Service Men's Department

Edited by JOHN F. RIDER

Leaves from Service Men's Note Books

By RADIO-CRAFT READERS

REMOVING THE SQUEAL FROM OLD RECEIVERS

By R. Wm. Tanner

NOT long ago, I was called out to service a receiver whose owner complained about excessive regeneration. An investigation of the set revealed a tuned R.F. circuit in which the volume and regeneration were controlled by means of a filament rheostat. When it was turned too high, regeneration was beyond control, and when it was adjusted below the point of oscillation, sensitivity suffered greatly. It was found that the R.F. transformers were quite small, approximately 2 inches long by 1-1/4 inches in diameter, and placed at right angles to each other. A close examination brought to light the fact

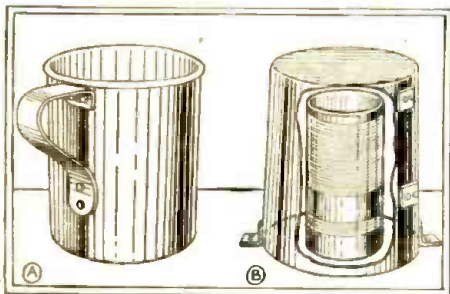

The common aluminum cup shown at A is transformed quickly into the R.F. coil shield at B. A "tin" cup, being made of iron, is not so well suited for this purpose.

that the primaries consisted of an over-abundant number of turns for the type of tubes employed, 601A's in this case.

The transformers were taken out and turns removed from the primaries until the turns ratio (between secondary and primary) was 3.5 to 1. After reinstalling, the set was again placed in operation, and tested. Regeneration was now more easily controlled; but still the owner was not satisfied, because the receiver still oscillated when the rheostat control was advanced. As a result, the receiver was taken into the shop.

It was decided to shield the radio-frequency transformers to eliminate any possibility of feed-back through inductive coupling. But where to obtain "cans," small enough to fit into the set, was a problem.

A trip through the "5-and-10 cent store" disclosed, at one of the counters, small aluminum drinking cups at 10 cents each. A set of these were purchased. Slight modifications were necessary before they could be put into service. The handles were removed and the rims sawed off; the result being very neat shields, with dimensions approximately 3 inches high by 3 inches in diameter.

As the amplifier parts were mounted directly on a wooden baseboard, it was necessary to cut a bottom piece for each shield.

\$25.00 EVERY MONTH

Will be paid for the most interesting story by a professional reader, containing his practical experiences and something of value to most other service men. It will appear on this page; together with other helpful contributions, which will be paid for at the regular rates. Send in your story; in any shape so long as it is both understandable and interesting. Address the Editor, RADIO-CRAFT.

These were made of aluminum (copper will do just as well) 3 inches in diameter; the thickness is of no importance. Two small brass angle brackets were employed to fasten each can to the base, first attaching the bottom pieces to the base with wood screws. The transformers fitted inside, with sufficient space between the windings and sides of the cans.

After the shielding job was done, the receiver was again tested and found to be quite stable in operation although, when the rheostat was turned to the "full" position, oscillations could be generated. However, as the rheostat need never be turned that high, the operation was now perfectly satisfactory.

I have since installed these efficient little shields in numerous receivers; especially those constructed a few years ago when shielding was almost unknown, with perfect satisfaction to the owners.

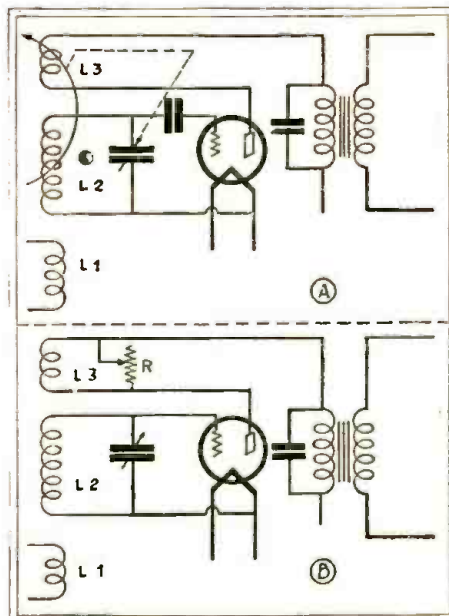

The "President" model, of the S. Freshman Co., couples a tickler to the condenser shaft as at A. For distance reception, Mr. McElwee finds the added control R, as at B, more satisfactory to regulate regeneration.

RAPID METHODS OF LOCATING FAULTS IN RADIO RECEIVERS

By Delbert Myers

FAULTS occurring in radio receivers are all similar in characteristic manifestation.

One common trouble or fault in both type sets is tube failure. For rapid work we proceed by the process of elimination. All tubes are tested for emission, and possible shorts, and all faulty tubes are replaced.

To test put receiver in operation. Remove detector tube and replace. If this action produces a click, we can consider that the audio system is O. K. Tapping the detector

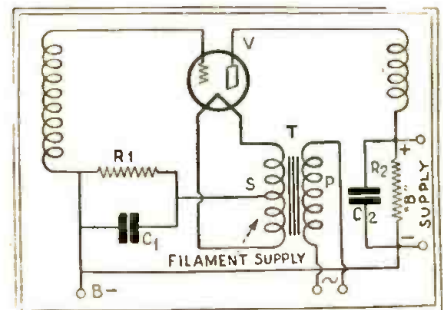

The elements of the voltage supplies of an A.C. filament tube; check first speaker; then, tubes, voltages, and receiver circuits, says Mr. Myers.

tube lightly with the finger should produce a ring in the speaker if the detector and audio system are O. K. We, therefore, eliminate this part of our circuit. Next pull out the tube in the radio-frequency amplifier preceding the detector and replace. If click is heard the trouble is in preceding stages. Take each succeeding R.F. tube out of socket and replace. If one of the tubes does not produce a click the fault is in that stage or in one of the preceding stages. This process will work for any part of the circuit.

Lack of proper voltages in power supply will give misleading readings in set testing. Once the tubes and power supply have been checked they can be eliminated from our list of faults. Before looking for trouble in the receiver test the speaker. For rapid work a set of head phones should be carried and substituted for the speaker. When we are sure that all the accessories are O. K., we are ready to apply our former tests.

SERVICING THE FRESHMAN "PRESIDENT"

By Fred McElwee

THE variable tickler coil in the detector circuit of the Freshman "President" model which controls regeneration occasions complaint frequently. The regeneration varies with the line-current, and the control requires frequent readjustment.

To remedy this, I took the tickler-coil

mounting from the gang-condenser shaft, and mounted it on a small block of wood; drilled a hole in the bottom of the shielding, and fastened the block of wood with a screw inserted from the under side of the shielding. Then I fixed the winding about 1/8-inch from the secondary end of the R.F. transformer. (Some sets require closer coupling than others.) I then mounted a good variable resistor of 200,000 to 500,000 ohms on the panel, and connected it in shunt with the tickler coil across the leads.

This makes the set a little more tedious to tune, as the resistor has to be adjusted on almost every station, to bring the regeneration up to maximum; but the performance is more satisfactory. (The writer is located in Lamoni, Iowa.—Editor.)

I have found that low plate voltage on '26 and '27 tubes is usually caused by loose or corroded rivets in the clips that hold the resistors in the power pack. To remedy this, solder the clips to the strip to which they are riveted.

The gang condenser should be balanced whenever tubes are replaced; as the difference in the capacity of the tubes unbalances the tuning circuits. To balance these, I use an oscillator to furnish the signal. As this gang has no balancing condensers, I bend the tip of the outside rotor plate to the amount required to balance each circuit.

ELECTROLYSIS IN TRANSFORMERS

By Ralph Link

I WAS called recently to repair a set, which I went over with a tester of standard make. No faults were located. The batteries were new, and the set checked all right. Signals, however, were very weak.

I found that the audio transformer was leaking to the core, when I disconnected the "C" battery; as I then noted a spark. A very careful examination of the transformer followed; I took it apart carefully and noted a deposit of copper on the iron core. I unwound the primary, starting next to the core, and found the first layer of wire eaten

away. I soaked in hot, distilled water a piece of the fiber insulation that was wound around the core, and found that it contained acid. This was the cause of the trouble.

Since the fiber contained acid, and the core was grounded to the metal sub-panel, while the "B+" was hooked to the end of the primary winding next the core, electrolysis had taken place, and deposited the copper on the iron core.

A good way to eliminate such trouble is to insulate the transformer from the metal sub-panel, and connect the "B+" wire to the core, as well as to the "B+" terminal of the primary. This places both at the same potential and stops electrolysis.

WHAT IS THE COMMONEST TROUBLE IN THE DETECTOR CIRCUIT?

RADIO-CRAFT especially invites its readers to send in their answers to this question during the coming month, so that we may have, as it were, an open forum on the subject in our April issue. Each month a different subject for discussion will be propounded. All replies received on this subject will be considered also as eligible entries in the \$25.00 Monthly Prize Contest, described on the preceding page.

A CONVENIENT TEST FOR GROUNDED CIRCUITS

By Dwight L. Brown

HERE is a suggestion for a simple tester suitable for locating grounds and testing continuity; provided that the current flow in the circuit—which is about 100 milliamperes—is not excessive for whatever device is in the circuit. It is admirably suited for rapid checking and is inexpensive.

It consists of a porcelain lamp socket; a wooden base, 2 1/2 x 6 inches; about ten feet of lamp cord and a receptacle plug; four small staples, two 8-inch lengths of stiff copper wire (No. 8 to 14); a ten-watt electric light bulb; and six feet of single-strand cord.

Mount the socket on one end of the wooden base, fasten one end of the lamp cord to one side of the socket, putting two staples over it and into the base as shown. Staple the other cord to the base with one staple. Cut the insulation back on the cord about three inches; and splice it to a three-foot piece of the single cord, being careful to solder it and tape the joint well. On the loose end of the single cord, cut the insulation back and solder it to one of the pieces of stiff wire, taping it well. Fasten the remaining piece of cord to the socket, and similarly solder to it, and tape over, the other piece of stiff wire. Staple this cord to the base so that it will not pull loose.

To use the tester, insert the plug in a light socket, screw the bulb into the socket, and place the prongs in contact with each other. The bulb should light. Now, when you test a circuit with the points, it is closed if the lamp lights; it is open or very high-resistance if the lamp does not. This outfit is also convenient as a light for the workbench, in which case a larger bulb is used.

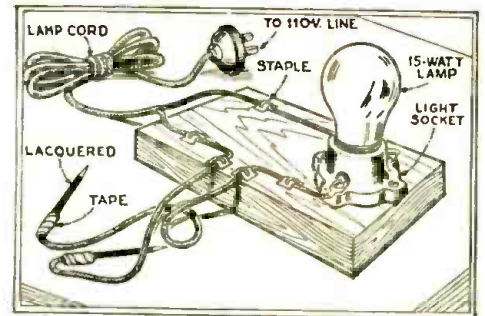

While the cheap, convenient tester pictured is known to many service men, there are others who will find it a useful addition to the kit.

THOROUGH TEST METHODS

By E. J. Montague

THE writer has run into all kinds of troubles in radio receivers, and I find that none of them are hard to locate if the mechanic really knows what he is doing. Stating it mildly, there are very few parts in a set that are not more or less duplicates of some other part; or, putting it more plainly, there are three important parts or sections in a complete receiver, i.e., R.F. circuit, detector, and A.F. circuit. The proper use of a combination R.F. and A.F. oscillator will tell the tale to a good mechanic in a very short time; and without this instrument we are totally in the dark.

My test on any receiver goes something like this. In the customer's home I use one of the medium-priced set testers (Readrite No.9) to test the tubes and all circuits electrically. If there is an open- or short-circuit it shows up at once and if it is in the external wiring of a part I repair it then and there. So my outfit for service consists of the tester mentioned, a set of phones with output transformer for testing the output—if any—and tubes, etc., for replacement. If the trouble is oscillations or low volume I take the set to the shop and give it a thorough test under all kinds of conditions. In other words, I duplicate the parts; I put a test R.F. amplifier on the detector; next I cut out the detector and substitute it and the same with the audio. Once the location is found (i.e., what part of the circuit is wrong) it is, as I explained, very easy to remedy.

I find that most of the trouble in the wiring is due to the failure of the assembler to adhere to the first law of wiring; e.g., all joints to be electrically and mechanically secure without solder.

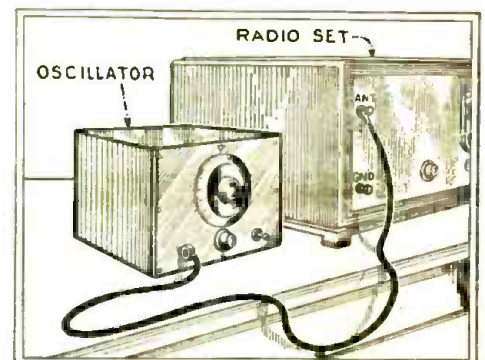

With some receivers, an oscillator must be coupled directly to the circuit, as shown. It is sometimes possible to obtain a sufficient signal, for balancing and testing, by inductive pick-up.

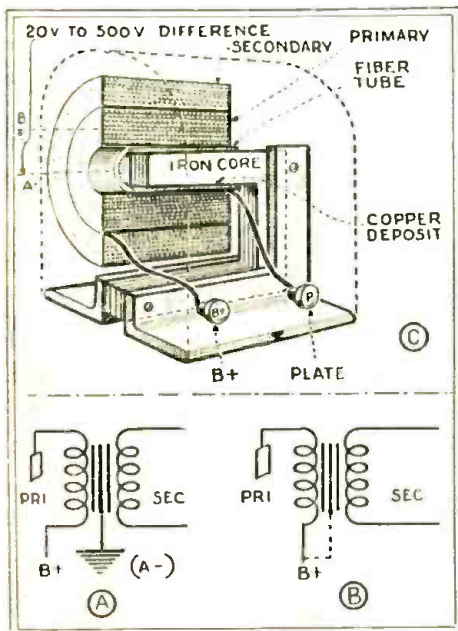

In place of grounding the core of an A.F. transformer, as at A, Mr. Link connects it to "B+" as at B. In a transformer which he dissected, electrolysis was apparent from primary to core, as at C.

Completeness in Radio Testing Equipment

Unusual ingenuity is shown in the design of a unit which places the precision equipment of a radio engineer's test-bench within a convenient carrying case

By H. G. CISIN, M.E.

SCIENTIFIC and systematic methods of locating and remedying faults in radio receivers have been developed to such a fine point that they now exceed in precision, speed and efficiency the methods used in testing all other types of electrical apparatus. Just as the clinical thermometer, the stethoscope and the X-ray aid the physician in locating trouble in the human body, the test set enables the service man to find elusive faults in the radio receiver.

There has long been a great demand for a universal set analyzer, or comprehensive set tester which would indicate more than can a number of ordinary testing meters connected in the usual way. After the universal adoption of "electric" sets, with their "chassis" construction, special mounting, and intricate circuit wiring, this demand became insistent. To meet it, a special test set, called the "Diagnometer", has been designed. (Fig. A.)

Instruments Comprised

All the working components of this set tester are contained within a hardwood "instrument tray" (Fig. B) measuring $4\frac{1}{2}$ " by $5\frac{1}{2}$ " by $17\frac{3}{8}$ ". This fits into a substantial carrying case (Fig. C) which has compartments for all tools, spare parts, tubes, etc., needed by the service man. The carrying case, completely equipped, weighs twenty pounds.

The instrument tray has a bakelite panel on which are mounted three precision meters. One of these is a four-scale D. C. voltmeter, one a four-scale A. C. voltmeter, and one a three-scale ammeter-milliammeter; all these are housed in bakelite cases. Removable-plunger switching controls are provided. Pin jacks for an oscillator coil

are situated at the left portion of the instrument panel, while the tube-testing sockets are located at the right.

A self-contained power plant, consisting of a step-down transformer, is built directly into the Diagnometer. The primary connects to the house-lighting circuit, while a tapped secondary is used to provide the voltages which may be required for testing any type of tube. By means of the switches, any desired voltage may be applied to the tube-testing sockets.

Line-voltage readings may be taken at any time during tests, through the use of a "master plunger".



Fig. A

The meter equipment of the panel is visible in this top view but gives no idea of the versatility of its uses.

The step-down transformer is used also to operate a tube rejuvenator. In addition, it supplies current for the oscillator.

Connecting cables, plugs, tube sockets and adapters are provided to facilitate the testing of various tubes and circuits. A "universal analyzer" plug of ingenious construction permits socket analysis, regardless of the type of socket (UX or UY), with all connections brought into the instrument through the same cable.

These parts are shown in a separate illustration, Fig. D. The numbers correspond to the following accessories: 1, three 12-inch jumper cords of heavy, flexible wire, silk-covered and tipped with fiber-covered plug-in connections; 2, 3 and 12, bakelite "master plungers" controlling the switches; 4, a heavy but flexible five-foot silk-covered wire, terminating at one end in a bakelite-covered six-inch test prod, and at the other in a smaller one, both "poled" red; 9, a similar item, poled black; 5, plate-break adapter with two separate "tinsel-cord"



Fig. B

The "instrument tray," protective lamp, oscillator "spiderweb" coil, etc., are shown here. The tip-jack layout is on the front.

leads; 6, plug-in oscillator coil, spider-web type; 7, a "UX-to-UY" adapter; 8, short lead for lengthening a screen-grid connection; 10, "99-to-UV" adapter; 11, two 12-inch jumpers terminating in small clips and plugs; 13, "UV-to-99" adapter; 14, six-ft. test cord ending in a test clip and a connection plug; 15, light-line connection cord, six feet long and arranged with a receptacle which wires a 100-watt lamp in series.

Protective Devices

The meters of the Diagnometer are protected, as much as possible, from accidents and errors, by ingenious devices. The milliammeter, which is normally on the 125-mil. scale, is protected under these conditions by an "overload relay" which will shunt the meter if more than about 140 mils are passed through the instrument. The 25-mil. scale is available when a small push-button is pressed; this button will not stay down without pressure, so that the meter is normally on the safe scale. The $2\frac{1}{2}$ -ampere scale is available from pin jacks on the back.

In working from the A. C. line, the 100-watt bulb is used in series; so that a shorted tube or other defect will not damage any of the internal equipment. The 100-watt bulb will limit the current passed through the Diagnometer to approximately one ampere. A shorted tube or other accident in the operation will give a visible indication; for the bulb will light.

It is, of course, impossible to prevent an inexperienced man from placing several hundred volts on a low-scale voltmeter and so burning the meter out; but, except for this highly improbable circumstance, the meters should stand up indefinitely.

A Portable Laboratory

It is interesting to record some of the major tests possible with the Diagnometer. Probably one of the most important is to determine the condition of the various tubes used in the radio receiver.

The unit can test any type of tube, in-



Fig. C

Diagnometer's "instrument tray" and its numerous accessories when packed in this case, weigh but twenty pounds.

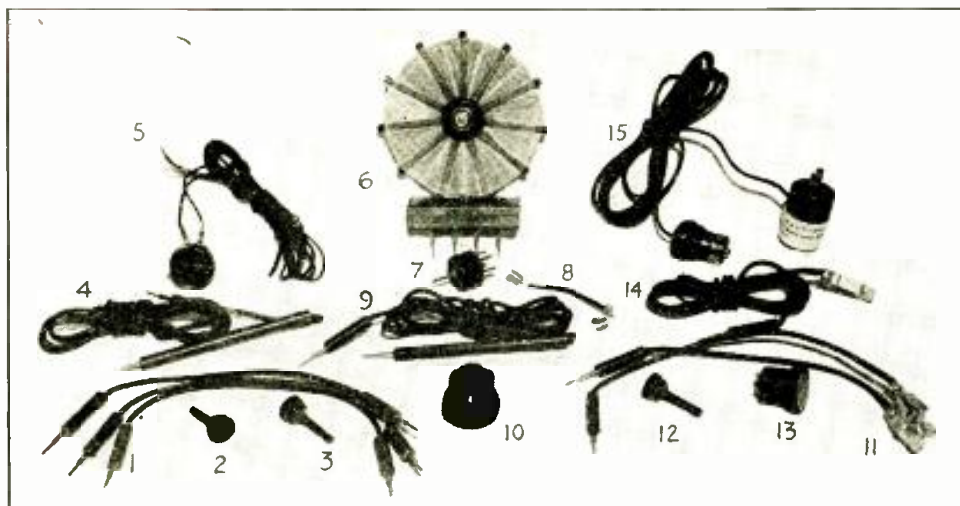

Fig. D

The numerous accessories required to complete the equipment comprised in the "Diagnometer"; most of them are known to the experienced Service Man but a few are special.

cluding the new A. C. screen-grid tubes, 15-volt tubes, "top-heater" tubes, and others which cannot be handled by the ordinary "tube checker". Tube testing is accomplished by subjecting the tube to an "oscillator test" in the oscillating circuit of the modulated radiator, which has constant values.

In comparing the result of an oscillation or "dynamic" test with a "static" test of tubes, it will be found that two tubes may show practically the same response to one or two small grid D. C. changes, but entirely different characteristics under an oscillation test. This feature clearly establishes the value of the latter.

Tables are provided with the test set; so that the service man can tell the condition of the tubes under test within a few seconds after taking two simple readings.

In passing, it should be noted that the instrument tests both plates of '80 type rectifier tubes; this is an important advantage, since one of these full-wave rectifiers often causes the set to hum badly, if there is a difference of more than 12 to 15 mils between the two plate readings.

Another important feature of this "laboratory" is the "modulated radiator." This is a regular "CW" radio transmitter, capable of providing oscillation tests on practically all types of tubes; as well as furnishing "audio-modulated radio-frequency" signals for synchronizing and calibrating tuning condensers, neutralizing radio frequency circuits, and, through its audio-modulated wave, checking up the performance of a radio receiver under actual operating conditions.

The Diagnometer can be used also as a resonance indicator. The modulated radiator sets up radio-frequency signals to which the receiver with condensers to be synchronized is tuned. The modulated R. F. signal is amplified by the radio set, and inductively fed through a *thermo-couple* to the D. C. voltmeter. The process of synchronizing consists of adjusting each tuning condenser until a maximum reading is indicated on the voltmeter. (Two other methods of synchronizing are available but in general the procedure is the same.)

Perhaps a little more detail on the method of resonating tuned circuits when the A. C. voltmeter method of indication is used will

be of general interest. To put the resonance indicator in operation: (1) Disconnect the aerial and ground from the receiver; (2) connect the "+ or - A. C." and the "1.0-mf." external pin jacks of the instrument to the loud-speaker terminals of the radio; (3) close one of the "A. C. fil." switches; (4) connect a test lead to the "Ant" binding post of the receiver and bring it in close proximity to the modulated-oscillator's spider-web coil; (5) rotate the tuning knob of the receiver. (A decided deflection of the needle of the A. C. voltmeter will occur as each harmonic of the oscillator is "tuned in" on the radio set. Maximum needle deflection indicates resonance with the oscillator circuit of the "modulated radiator"); (6) adjust each tuning condenser for a maximum reading on a 60-cycle "modulated-radiator" signal between 1000 and 1500 kilocycles.

Determining Operating Conditions

To find the actual operating conditions of a radio set, the *analyzer plug* is placed in

each tube socket, and by closing the proper switch in the Diagnometer, it is possible to read filament voltages, plate voltages, grid voltages, plate currents, etc. "No load" and "load" readings may be made with equal facility. It is possible also to obtain cathode readings, either positive or negative, in circuits employing the heater-type tubes, to obtain screen-grid and control-grid readings, and to make all socket analyses in screen-grid circuits without introducing oscillations into the circuits.

The "analyzer" consists of the universal plug and its connecting multi-wire cable with its plate connection in series with the ammeter-milliammeter and the plate contact of the "load socket". All other wires of the cable also terminate at the corresponding contacts at the "load socket," which is also a part of the analyzer apparatus. The analyzer circuit includes the necessary switches for connecting the voltmeter across the cable leads to obtain the various voltage readings necessary in radio tube-socket analyzing.

Layout of Panel

The jacks, switches, meters and sockets that constitute the top panel equipment are shown in the pictorial illustrations, but the actual panel marking may be of interest. The items have all been given arbitrary reference figures in the layout representation, (Fig. 1) as follows:

At upper left appear four tip jacks for the oscillator-coil tips, lettered as indicated. Below these appear six switches (which are operated by plugging bakelite rods called "master plungers" and supplied with the kit, into these units which, on the outside, look like jacks) as follows: 1, 15-volt tubes; 2, 7½-volt tubes; 3, 5-volt tubes; 4, 3 to 3.3-volt tubes; 5, 2½-volt tubes; 6, 1½-volt tubes; 7, plate 750 scale; 8, plate 250 scale; 9, A. C. line, 150 scale; 10, cathode, 100 scale; 11 is a spring-and-button polarity reversing switch marked "Pole Changer"; 12, control grid "-" bias 10 scale; 13, (Continued on page 401)

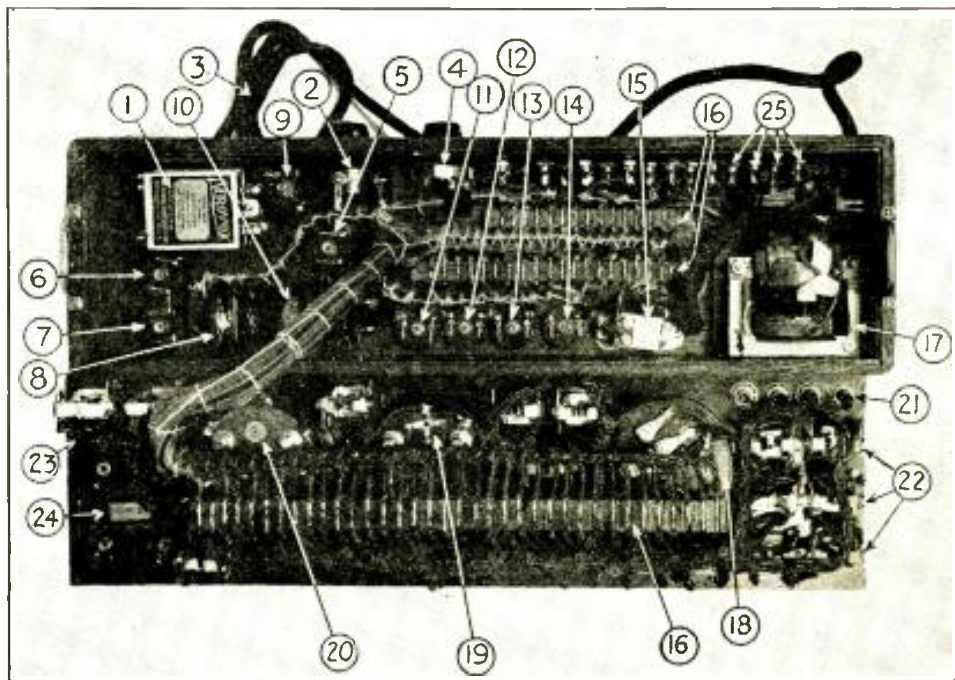

Fig. E

An interior "shot" of the "instrument tray," with what constructors call its "Western Electric," or cabled wiring. The design has been made as nearly fool-proof as possible; but accredited repair stations will find occasional adjustments are convenient.

Causes and Cure of Radio Interference

(Part II)

This article, analyzing all radio interference, contains diagrams and data which will be of value to Service Men and all others who are faced by the necessity of eliminating troubles of this kind

By F. R. BRISTOW

Supervisor, Home Study Division, R.C.A. Institutes, Inc.

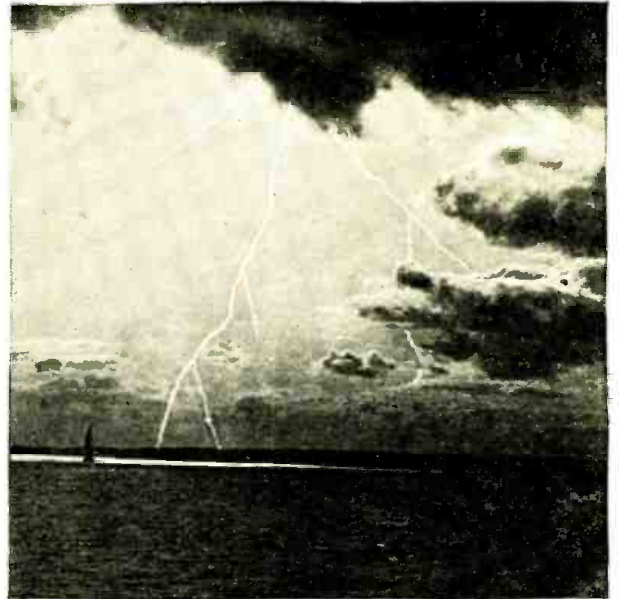

Fig. A

Unfortunately, no one has found a way to connect a filter across Nature's sources of static—such as this fine specimen here.

"STATIC!" How often we have heard that word! And, because static electricity concerns us at this time, we should know something more about it. "Atmospherics" and "static" are synonymous expressions for the roaming electrical phenomena which nature produces.

The atmosphere of the earth is filled at all times with what are termed "charges of free electricity" (static electricity). Its exact origin remains one of the secrets of nature.

A most vivid manifestation of the presence of static charges in the air is seen during thunderstorms; the lightning seen at such times is the discharge between the clouds and earth (and between cloud and cloud) of a great accumulation of static electricity. A discharge of this nature is immediately made known by the emission of a characteristic crashing noise from the loud speaker. We say this noise is caused by *static*.

Fine weather may prevail at the location of the receiver; but the lightning discharges of a distant storm (thousands of miles away) will still affect a sensitive receiver.

Carriers of Static Charges

When listening-in to a program during a rain or snow-storm, it is not an uncommon occurrence to receive a slight hissing sound.

The raindrops and snowflakes are carriers of minute static charges and, as one comes in contact with the aerial wire, it imparts its charge to the aerial system. Each of these charges sets up a minute current which passes through the receiving circuit to earth, producing in the tuned circuit a slight oscillatory impulse which, in turn, is emitted from the speaker as a hiss.

which affect the reception of radio broadcast programs originate from different sources; and create interference on *all wavelengths*.

Many devices have been invented in an attempt to eliminate or appreciably reduce "static"; but so far the only practical methods are those of employing loosely-coupled circuits and short antennas, and of using a loop. Static eliminators which have produced encouraging results are so elaborate as to prohibit their general use with broadcast receivers.

(We may remark that almost every radio experimenter has tried at one time or another to invent a "static" eliminator, if we may judge from our correspondence. The trouble is in the nature of broadcast reception, which demands reception from all directions—commonly with a fixed aerial—and reproduction of a wide band of audio frequencies. A radio-telegraph system, used often from "point to point," has a very narrow frequency-band.—*Editor.*)

Noise Originating in the Receiver

Some noises which interfere with a broadcast program are thought to be caused by static; when, in reality, they originate in parts of the receiver! It is much better to classify such interference as plain noise; because static, strictly speaking, is the result of an antenna system absorbing electrical disturbances present in the atmosphere. Receiver noises are due to faulty units of the set, its accessories, poor design, and careless construction work.

If the "on-off" switch becomes worn, the worn switch contacts are subject to minute vibrations which may cause the filament cir-

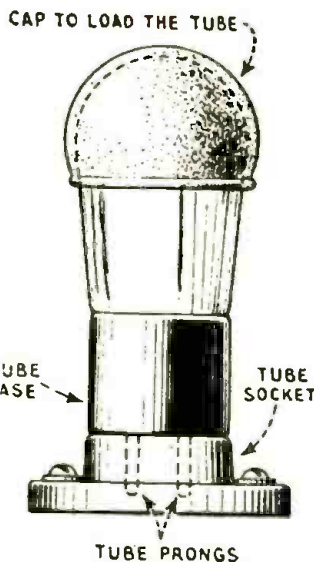

Fig. 3

The "heel arrestor" used with a microphonic tube simply keeps it from vibrating freely, and thus shaking its loose elements.

In dry hot weather the air is filled with small dust particles. These are also carriers of static charges which, on striking the aerial, give up their accumulated charges and produce interfering effects.

Other characteristic noises heard from the reproducing unit of a receiver, because of the effect of charged particles striking the aerial, are irregular "clicking" sounds or crashes resembling that which would be heard on throwing pebbles against a wall.

From the foregoing paragraphs it is understood that atmospheric disturbances

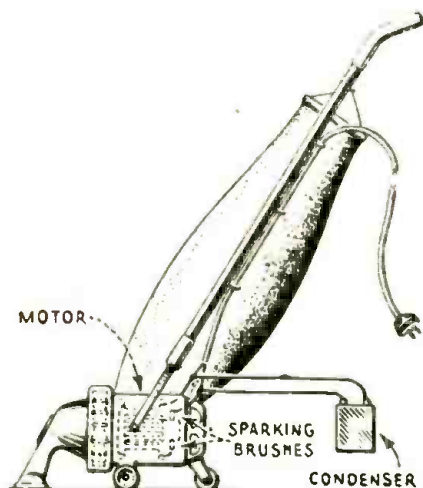

Fig. 10

A 1/2-mf. condenser, alone, as in Fig. 4, will deal with the type of "universal" motor used in a cleaner of this kind.

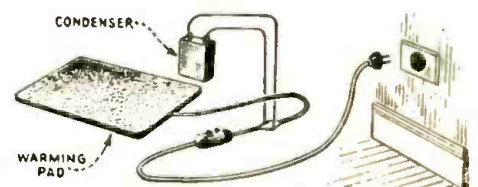

Fig. 12

The heating pad, using the make-and-break regulator of Fig. 13, should have a one-mf. condenser, as close up to the thermostat as possible.

cuit to open and close; and the result will be a continual series of scratchy sounds. A loss in sound intensity also may result.

Plates of variable condensers which become bent from any cause will short-circuit the unit if the bent plate touches one on the opposite side. When this condition occurs, a click or rasping sound will be heard from the loud speaker, or the signals will suddenly disappear when the condenser dial is rotated.

Faulty flexible leads to a movable coil will produce crackling noises when the knob is rotated.

Partially broken plate leads in the receiver will produce loud clicking noises. Poor "B" battery connections will produce the same effect.

Storage-battery terminals often become corroded and, if the corrosion becomes excessive, it will completely prevent the flow of current. The increased resistance to the circuit caused by battery-terminal corrosion will cause a faint high-pitched whistle in some receivers.

Any corroded, poorly soldered joint will cause undesirable noise.

Excessive dirt or dust accumulations around open wiring, between condenser plates, or on the spring contacts of tube sockets, is often the source of crackling sounds.

The elements of inferior tubes will often cause weird noises after they have been in operation for a short time. The reason is found in imperfect contacts or poor evacuation.

Defective grid leaks often cause crackles, sputtering and strange sounds which the experienced service man will recognize as being caused by such.

"Popping" which occurs at more or less regular intervals may be due to a grid leak of incorrect value. If this trouble is experienced, try to eliminate the popping by substituting several grid leaks of different values.

The Microphonic Tube

"Howling" may occur when the receiver cabinet or any of its controls is touched, or it may occur even when no one is near the receiver. This sound is usually caused by a "microphonic" tube. Two remedies are the purchase of a new tube or placement of the reproducer in another location.

Another remedy, a makeshift—but very often successful in preventing microphonic-tube howl—is to "load" the tube with a heavy cap slipped over it (Fig. 3). Spring sockets also tend to absorb shocks and vibrations which might cause the tube elements to vibrate. The vibration period of a tube, when weighted down with a heavy cap, is perhaps only seven or eight times a second. A sound vibration of so low a pitch, and of the intensity caused by microphonic contacts, is



Fig. 4



Fig. 5



Fig. 6



Fig. 7

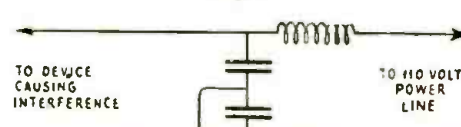

Fig. 8

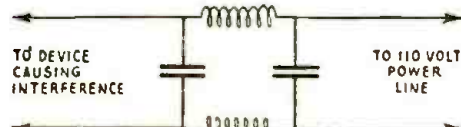

Fig. 9

These six filter types deal with interference of increasing degrees of difficulty. In each case, the problem is finding a capacity which will by-pass the R.F. current generated by the device served, because of the impedance on either side of it. In Fig. 6, the inductances may cause the self-capacity of the device itself to act as a sufficient by-pass.

far below the audibility range and will not be heard in the loud speaker.

The new A. C. tubes rarely show microphonic tendencies.

Let us explain why microphonic trouble occurs with one tube but not another. A "microphonic tube" is simply an ordinary tube in which one or more of the elements are loosely mounted when assembled. It is essential that all of the tube elements (grid, plate and filament) should be mounted and supported so that a rigid, fixed relation is maintained between them. If any of the elements vibrate, the spacing between them changes and thus the normal characteristics of the tube are changed.

For example, a tube having a low voltage-amplification factor is constructed with the grid and plate elements mounted close together; whereas in a tube having high voltage amplification the grid is placed comparatively close to the filament and at some distance from the plate. If sound vibrations cause a tube to move, then any loose elements within will also move. Any change in

the distance between these elements will cause the value of the plate current to be affected in proportion. The plate current variations are then magnified by the amplifying stages following the microphonic tube and are reproduced in the loud speaker as a swinging howl, varying in pitch according to the vibration period of the tube elements. In some cases interchanging tubes in their sockets will make the set workable. However, a tube having extreme microphonic tendencies should be thrown out.

Sparking-Device Interference

When a spark discharge occurs in an electrical circuit, interference may result. We call this "inductive interference."

When it is realized that every small electric spark, created by any electrical machine or apparatus, produces electrical waves of various frequencies, it is at once apparent that the antenna system of a radio receiver will intercept such waves, and convey them to the receiver in precisely the same manner as it does the high-frequency energy radiated from a broadcast transmitter. Since a microscopic spark is a possible source of interference, we find innumerable types of apparatus capable of causing trouble. To classify every conceivable kind of suspected machine or piece of apparatus would require a huge volume. The following list, however, gives a comprehensive idea of where to look for possible causes of interference. Automatic oil burners, electric washing machines, warning pads, electric refrigerators, clapper switches on elevator controls, electric vibrators, X-ray machines, motors operating dental equipment, violet-ray apparatus, bare power lines swinging against tree branches, telephone ringers, electric door bells and buzzers, trolley cars and elevated systems, farm lighting systems, high-voltage laboratory equipment, vacuum cleaners, electric sign flashers, defective lamp sockets, rapidly-moving leather belts, electric player-pianos, rotary converters, motion-picture equipment, defective electric flatiron plugs, are lamps, ignition systems, fused outlet boxes.

Remember that sparking is caused by the interruption of current flow during the operation of certain kinds of electrical apparatus, especially those designed to operate with a "make-and-break" mechanism.

Electric motors of all kinds are possible causes of interference. Sparking is generally produced in motors because of poor contact between incorrectly fitting brushes and the revolving commutator segments, or other contacting arrangements.

Thermostatic control devices, bell-ringing apparatus, and sign flashers are sources of considerable trouble. Thermostatic devices

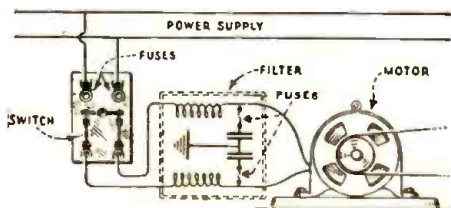

Fig. 11

A motor, such as a washing machine employs, is shown here with a filter of the type of Fig. 8.

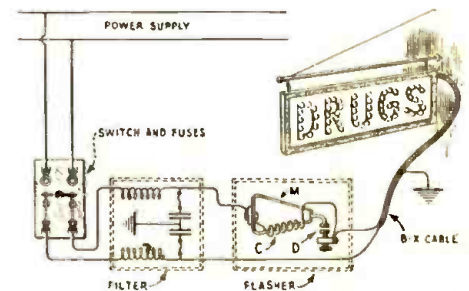

Fig. 14

A flashing sign, operated by a thermostatic switch, will require a filter of greater current-carrying capacity than a small motor.

cause interference because their operation depends upon the "make and break" of the circuit by means of contacts.

Poor connections in the wiring of lamp sockets, flatirons and electric toaster plugs, unsoldered or loosely-made splices, or the discharge or leaking of electrical energy to ground because of faulty insulators, are all possible sources of interference which usually manifests itself as "crackles."

The interference caused by high-frequency energy, transmitted when spark discharges take place, becomes increasingly objectionable as the intensity of the spark increases. A sudden variation in the strength of current flowing through a circuit, usually due to some fault in the circuit, will cause an effect known as a "surge." When a surge occurs, a wave-motion of many frequencies is set up in the space surrounding the particular circuit. A power line in which trouble of this kind exists will act like a transmitting antenna; because the long wire or wires assists in the radiation of an interfering wave of this nature which may travel great distances to either side of the actual location of the trouble. Disturbances of this kind are often very difficult to trace and, to cope with them successfully, special apparatus is required.

Elimination Procedure

To eliminate interfering electrical impulses, use is made of condensers, choke coils, or a combination of both. A unit of this kind is called a "filter." The assembly of a filter unit is a simple matter and in some cases its installation is by no means difficult. Caution, however, should be exercised when connecting such a device to a power circuit. Be certain that the installation is made in compliance with the rules of the Board of Fire Underwriters. Fire hazards are to be avoided in all cases.

Figs. 4 to 9 are schematic diagrams showing various filter circuits.

Exact specifications of the capacities of the condensers, or inductances of the choke coils, are not shown in these diagrams; because they vary under different conditions.

In many cases where filters are to be installed to eliminate interference, a certain

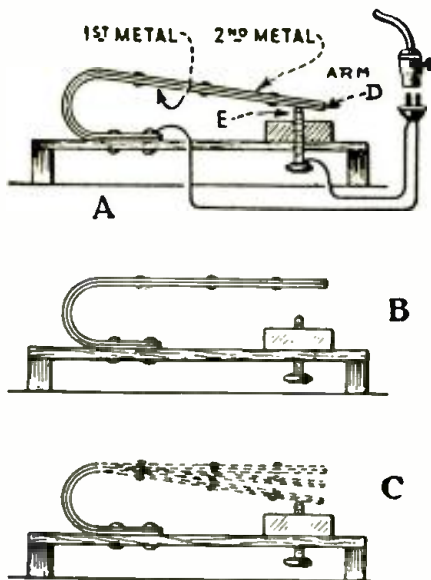

Fig. 13

The alternate heating and cooling of a thermostatic contact may set up rapid vibrations which cause very troublesome interference.

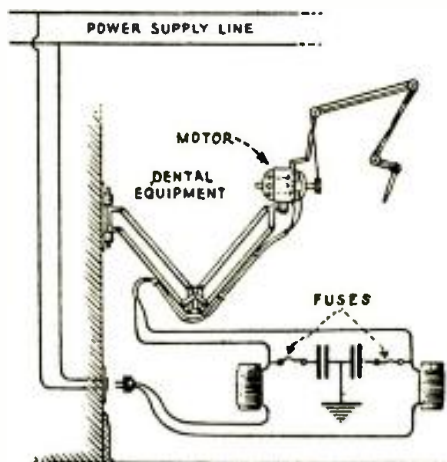

Fig. 15

A dental motor, of a type which can be very annoying, is shown with a filter of the type of Fig. 8. The chokes may be home-made.

amount of study of the particular situation will be required. One of the hook-ups shown should be employed. It may be necessary to substitute various values of capacity and inductance before the correct combination is found which will most effectively produce the desired results.

The filter condensers in any of the filter circuits shown should be capable of withstanding a 1000-volt (direct-current) test if they are to be connected across a 110- or 220-volt supply line.

The choke coils must be wound with the proper size and length of wire and mounted on a core of suitable dimensions to give the reactance desired. Also, the wire must safely carry the current flowing in the circuit in which the coils are connected. Another consideration is that the choke unit should not appreciably reduce the voltage required at the main machine.

Although "cure-all" rules cannot be given relative to condenser and choke-coil values, we cite a few of the more commonly used sizes.

Figure 10 shows a vacuum cleaner utilizing a small "universal" type motor. A small condenser rated at 0.5-mf. capacity is connected across the motor input terminals.

Figure 11 illustrates a washing machine motor, the circuit being equipped with a filter unit wired according to Fig. 8. Condensers rated between 0.5- and 1.0-mf. capacity are used in this filter; while the choke coils (having an inductance of at least 1.5 millihenries) are wound with about 100 to 150 turns of insulated copper wire on a 2½-inch form. The size of the wire depends upon the value of the current drawn by the motor.

It is possible that the filters shown in Figs. 4, 5 and 7 may eliminate interference set up by such motors. The capacities of the condensers and the construction of the choke coils in these circuits are approximately the same as in the similar units just described for Fig. 8.

Thermostatic Circuit Controls

The electrical heating pad, shown in Fig. 12, has a thermostatic unit producing the interference; for its details in a simplified form, see Fig. 13 at A, B, C.

Heating pads require the use of thermostatic current controls which are made up of two dissimilar metals, with different co-

efficients of expansion. During operation one of the metals expands more rapidly than the other and therefore, when a certain heat is reached, the rapid expansion of the metal forces the contacts apart, thus breaking the circuit as shown at B. When the arm "D" cools sufficiently it drops back on contact "E" as shown at "A" and current again flows through the thermostatic alloy. Because of certain conditions, arm "D" may open just far enough at times so that a small movement will set it in rapid vibration; causing the circuit to make and break several times in succession as shown at "C," and each time an arc will be drawn at the contacts. It is this action of the thermostat that causes interference from heating pads.

Fig. 12 shows a 1.0-mf. condenser connected across the line and as close as possible to the point where the connection wires come from the pad.

Signs that Broadcast

As a rule, the control mechanisms of electric signs are enclosed in a metal housing which is grounded to carry off any interfering waves caused by sparking when the motor-driven commutator makes and breaks the current supplied to the lamps.

Another type which depends upon thermostatic control is shown in Fig. 14. In this case the metal "M" is heated by a coil "C" which by expanding closes the contacts at "D," thus allowing sufficient current flow to light the lamps in the sign. Once the

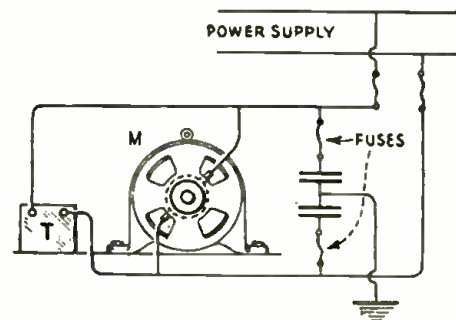

Fig. 16

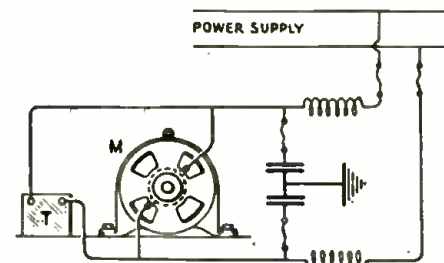

Fig. 17

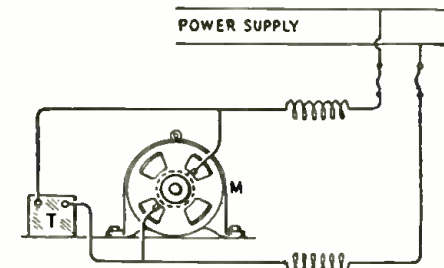

Fig. 18

The high-voltage ignition of an oil-burner is almost an ideal transmitter. It will be necessary to experiment with the types of filter shown to determine which gives most effective relief.

contact is made at "D," the coil "C" is short-circuited. The short-circuiting of coil "C" allows the bar "M" to cool; it then contracts, breaking the contact at "D," and opening the circuit to the lamps.

The condensers required in this filter range in capacity from 1.0- to 3.0-mf.; while each choke coil should consist of at least 250 turns of insulated wire wound on a form 3 inches in diameter. The wire must be of the proper size to carry, without overheating, the current drawn by the lamps in the sign. In certain types of signs, filter units employing two choke coils, like those shown in Fig. 8, may be required.

To reduce interference it is not always necessary to use condensers. Only choke coils are shown in Fig. 18; in which a filter unit of the type shown in Fig. 6 is used. (Complete details for the construction of simple air-core choke coils are given on page 219 of the November, 1929, issue of RADIO-CRAFT magazine.—Editor.)



Fig. B

The portable superheterodyne shown is excellently adapted to the work of tracing "man-made static" to its sources, because of its directional qualities.

driven into the furnace. In these filters the condensers should be from 0.5- to 2.0-mf.; while the choke coils should consist of about 150 turns of No. 16 D.C.C. copper wire wound on a 2-inch form to provide sufficient inductance. The coils may be lump-wound.

X-ray Equipment

In practically all instances X-ray equipment produces considerable radio interference which may be sufficient either to blot out the broadcast signals entirely, or at least cause interference which is very annoying when dealing with equipment of this kind. The service man should try out all of the various types of filters until one is found that will materially reduce the interference. It is not to be expected that all of the interference from machines of this type can be eliminated, even after applying any filter combination; because a great proportion of the trouble is due to energy radiated by the long high-tension leads leading from the apparatus to the electrodes. Shielding these leads is not practical, because it would interfere with their free use. The best method is to shield the entire room containing the equipment with a fine copper mesh (an expensive undertaking). X-ray equipment employing a rectifier of the rotary synchronous type is very troublesome in the matter of setting up interference.

Motion-Picture Equipment

A motor-generator, such as are employed to furnish power to the arcs of a motion-picture projector, often causes interference in receivers at distances of 300 yards or more. A simple filter of the type shown

in Fig. 5 will in most cases improve conditions; the capacity of each condenser should be at least 2.0-mf. The filter unit is connected across the generator output, as shown in Fig. 19, with 5-ampere fuses included as indicated in order to protect the generator in the event of a short-circuit or breaking down of either condenser. The filter unit should be enclosed in a metal box.

The filter shown in Fig. 9, which is called a "compound choke," has often proven successful in eliminating interference when all other combinations have failed. Usually, however, it will be necessary to employ a filter of this type only in extreme conditions. The correct values for the fixed condensers are determined by the degree of interference.

Figure 20 shows a filter connected in a "three-wire" system. The wire used in the choke coils must be large enough to carry the current drawn from the line without heating the coils. The condenser values in

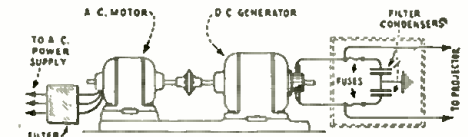

Fig. 19

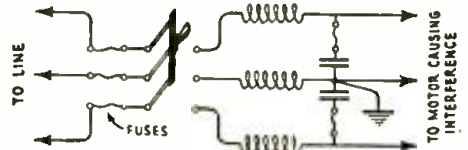

Fig. 20

The motor-generator combination will require a filter on each side, as shown above. The three-wire system is grounded in the center, but even here a choke coil may be helpful.

this unit vary from 0.5 to 2.0-mf.; and it should be fused with 5-ampere fuses.

Figs. 21 and 22 show how some electric irons may be sources of interference, due to sparking when the iron is moved across an ironing board. The remedy in such cases is to repair the defects either by installing new parts, or by making good soldered splices, as the case may be.

Power Lines

Lines carrying high-potential currents are always a possible source of interference. The radio service man should never attempt (Continued on page 405)

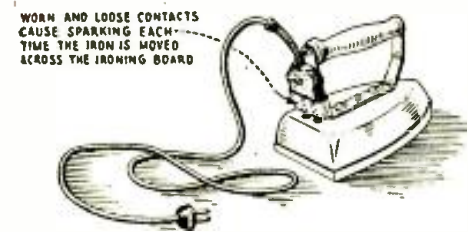

Fig. 21

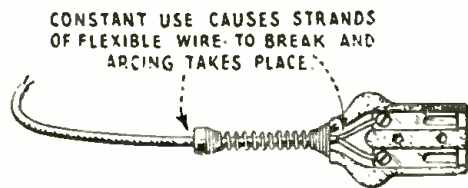

Fig. 22

Even an electric iron in use may cause trouble—because of some imperfect contact made by its cord.

Motors and Ignition Systems

Dental motors often cause interference in radio sets located several hundred feet from the actual place where the motors and dental equipment are installed. In such cases one of the filter units shown in Figs. 5, 7 or 8 will usually clear the trouble. The rating of the filter condensers in Fig. 5 should be at least 1.0-mf.; in Figs. 7 and 8, approximately 0.5-mf. capacity. The choke coils should consist of 80 or 100 turns of No. 14 D.C.C. copper wire, lump-wound on a 2-inch form. This means that the turns may be placed on the core without regard to any particular arrangement, as when a coil is single-layer or bank-wound. A typical dental installation is shown in Fig. 15. The filter used here is shown also in Fig. 8.

The electrical equipment of automatic coil burners often causes interference, when in operation; but, since different oil burners may not respond to the same treatment in order to eliminate radio interference, specific remedies cannot be given. A few general methods of procedure, however, are available; as shown in Figs. 16, 17 and 18. In each of the diagrams the transformer 'T' is of the high-tension type, developing a potential in the neighborhood of 10,000 volts across its secondary. This high voltage is used to ignite the vaporized oil as it is

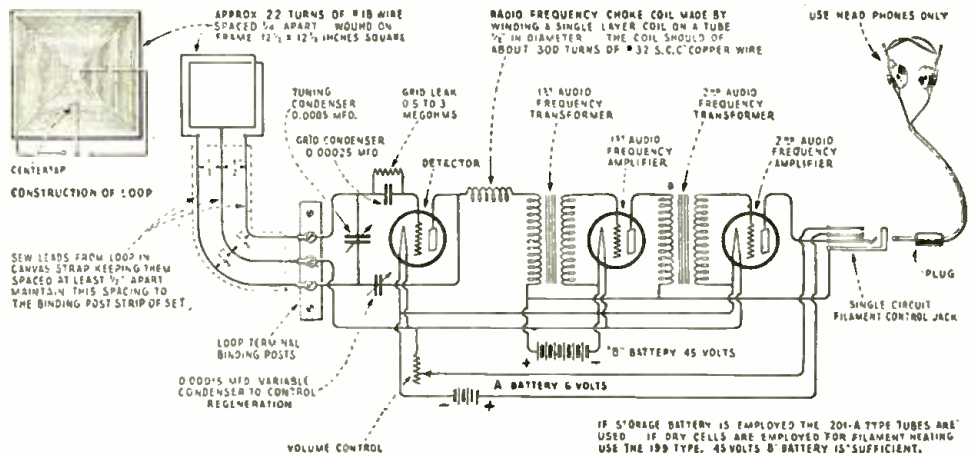

Fig. 25

The schematic circuit shown above is that of a loop-operated regenerative receiver, well adapted to the location of interference. The constants are given in the sketch. Such a receiver should be completely shielded; it may be constructed very compactly and lightly for the work described.

Operating Notes for Service Men

Keeping the customer happy is the business of Mr. Freed. How he does this in specific instances is described in this article.

By BERTRAM M. FREED

SOME Zenith sets are subject to the complaint that stations cannot be heard above 50 on the tuning hook to the tuning condenser scale. The variable condenser plates are made of a soft metal, and a mechanical shock will bend them, causing a short. If it should be necessary to make a soldered connection to one of these condensers, remember to make the contact of the soldering iron of very brief duration, or the condenser itself will be melted away.

Set Peculiarities

When fuses "blow" every time a Colonial "31AC" is turned on, save time and trouble by examining the *condensers* across the A.C. input side. (See Fig. 1.) Check these for a short, and consequent ground.

When a house fuse goes with the Radiola "18AC," test the pair of 110-volt *rectifiers* which feed the field winding of the dynamic speaker (Figs. 2 and 2A). They should show a resistance of more than 3,000 ohms, if in good condition. Also, if this model develops a hum, test the resistance of these rectifiers; remove the connections to their elements, and test separately. If a partial short or reduced resistance is shown, they will cause a hum. Replacement is

indicated, in case defects are found.

If this set tunes broadly, it is possible to remedy the complaint by reducing the value of the grid suppressors; this, however, will often introduce unwanted oscillation. To maintain the normal sharpness of tuning, while preventing oscillation, con-

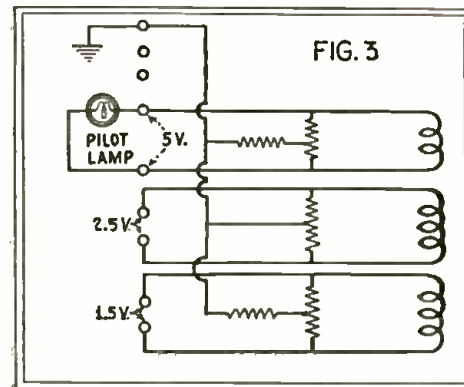

Center-tap, biasing and pilot-light connections of the "Radiola 18AC."

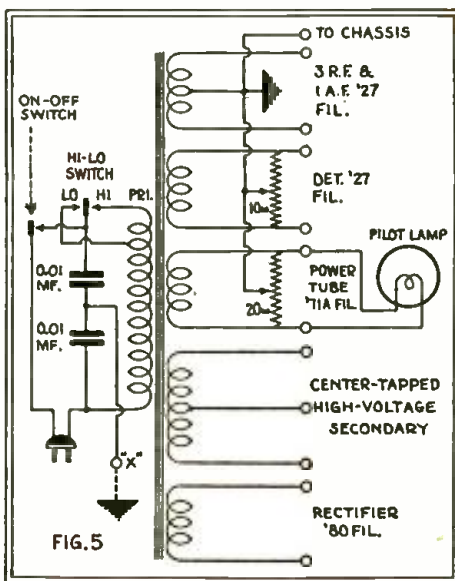

Details of the Stromberg-Carlson "635" and "636" to which reference is made below.

nect a 500-900 ohm resistor across the primary of the third R.F. coil. This procedure has helped in every case when it has been tried.

When an absence of screen-grid plate voltage, and a corresponding drop across other tubes, is found in the Zenith "42," the fault is in the first tuning condenser's compensator. There is a very thin circular piece of mica between the plates of this compensator, and a hole through it shorts

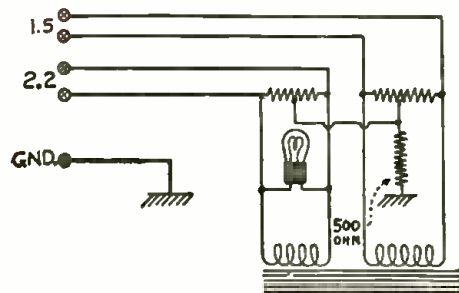
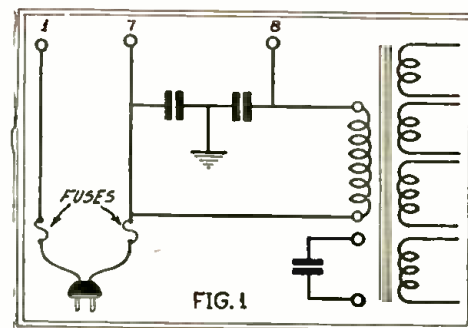

Fig. 4

How a single resistor biases five tubes in the Bosch "28" and "29."



Line-connections of the Colonial "31AC": 1 (maroon) and 8 (blue-white) lead to set switch; 7 is yellow.

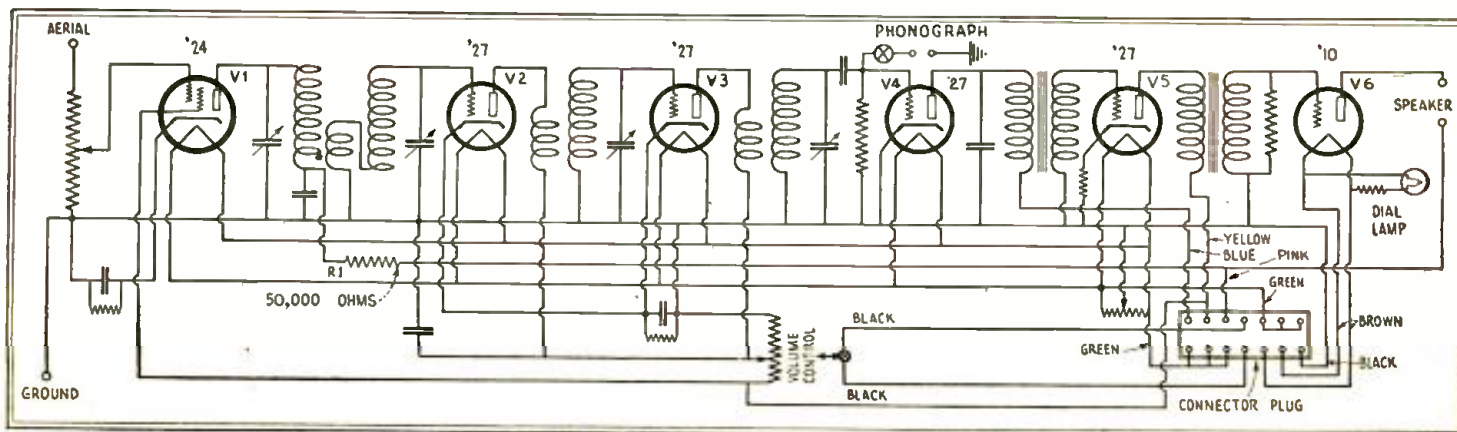

Fig. 6

The Zenith "42" in schematic circuit up to its terminal block. Volume control and switch are a unit. Note position of tuning condenser in the '24's output; also connection of the phonograph pick-up for audio amplification by V4.

A Complete Portable Radio Testing Laboratory--Part II

The author describes the operation of the very complete testing equipment for which circuit diagrams, layouts, and specifications were given in the January issue of RADIO-CRAFT

By GEORGE C. MILLER

The Ohm-meter

The ohmmeter, Fig. 2 is the most useful thing a service man can carry. A test set is not complete without one. The one in the set tester has 4 ranges. Using one cell of the "C" battery; namely, 1½ volts. The maximum reading of it is 15,000 ohms and with two cells of the battery, this would be increased two-fold to 30,000 ohms and with the full 4½ volts of the battery it would be

45,000 ohms. The 10 milliamperes shunt when used, will greatly increase the useful range of the instrument by cutting the scale by ten, thus the 1½ volt range would have a 1500 maximum reading instead of 15,000. Theoretically the maximum reading of all scales is infinite, but due to the crowded condition on the upper end of the scale the easiest reading determines its useful range. The meter is calibrated according to $R = E (1/I - 1/i)$. Current in amperes, not milliamperes, and the "E" is the voltage of the battery used. If we put an unknown resistance across the binding posts, E is the battery voltage and I is the current shown by meter with the resistance in circuit. 1/I is the constant for the meter and is the reciprocal of the full scale reading of the meter used, namely 0.001 in this case. This equation does not take in consideration the voltage of the battery; as any change in battery voltage is taken care of by the variable resistance. This resistance is adjusted for full scale reading before making any measurements. To get a calibrated curve, values for I are chosen as scale divisions on the meter and these values are inserted in the equation. A number of points are thus obtained and a curve can be made of these and from said curve on paper the scale of the meter can be recalibrated. To adjust the meter for operation take the two leads from the binding posts and short them. Then adjust variable resistance till meter indicates full scale de-

flexion, namely, 1 milliamperes, equivalent to a zero reading on the ohmmeter scale. Then separate the leads and the meter is ready for operation and measurement of the D.C. resistance of any piece of apparatus directly in ohms.

General Tests

Tungar tubes and helium rectifiers should be tested under load in their respective cir-

length beyond the range of the small midget condenser. The R.F. choke is not critical and any one choke can be used. Figs. 3 and 4 show some of the tests possible upon a vacuum tube. (See preceding article.)

The Tube Tester and Rejuvenator

This instrument is the outcome of a Sterling model R-510 tube tester and rejuvenator and is handy when you go to a person's house to test his tubes. The Sterling R 510 is complete as shown except that the panel was altered to match the remainder of the equipment. The binding posts are mounted upon the panel so as to enable utilization of the transformer inside the tester, thereby providing a means of securing small values of AC voltage and current. It will furnish any voltage from ½-volt to 18 volts. In the event that the filament might be desired for use with outside heater type of tubes, they terminate close to the socket with AC leads in the centre and plate and grid leads on either side. It was then necessary

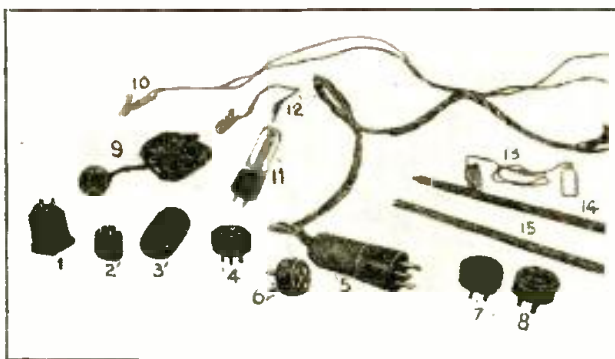

Fig. C
The accessories shown here are: 1, UV-to-UX adapter; 2, UX-to-UV adapter; 3, A.C. test adapter; 4, UX neutralizing adapter; 5, 5-wire cable lead, and 5-prong tube base, with "broom-handle" top; 6, 5- to 4-prong adapter for cable plug; 7, UY neutralizing adapter; 8, W'D-to-UX adapter on cable; 9, 6-ft. cord for A.C. tests, with plug and tips for oscillator use; 10, test leads; 11, '99 tube; 12, screen-grid lead; 13, short testing lead; 14, neutralizing tool; 15, aligning tool.

45,000 ohms. The 10 milliamperes shunt when used, will greatly increase the useful range of the instrument by cutting the scale by ten, thus the 1½ volt range would have a 1500 maximum reading instead of 15,000. Theoretically the maximum reading of all scales is infinite, but due to the crowded condition on the upper end of the scale the easiest reading determines its useful range. The meter is calibrated according to $R = E (1/I - 1/i)$. Current in amperes, not milliamperes, and the "E" is the voltage of the battery used. If we put an unknown resistance across the binding posts, E is the battery voltage and I is the current shown by meter with the resistance in circuit. 1/I is the constant for the meter and is the reciprocal of the full scale reading of the meter used, namely 0.001 in this case. This equation does not take in consideration the voltage of the battery; as any change in battery voltage is taken care of by the variable resistance. This resistance is adjusted for full scale reading before making any measurements. To get a calibrated curve, values for I are chosen as scale divisions on the meter and these values are inserted in the equation. A number of points are thus obtained and a curve can be made of these and from said curve on paper the scale of the meter can be recalibrated. To adjust the meter for operation take the two leads from the binding posts and short them. Then adjust variable resistance till meter indicates full scale de-

circuits by testing the current output. Voltage regulators of the '74 type are supposed to hold the output voltage constant. "B" eliminators at 90 volts can be tested with test wires and the meters, the voltage drop and output voltage of ballast tubes can also be measured in order to judge their condition. The '76 and '86 types are alike except that one is rated at 1.7 amperes and the other at 2.05 amperes.

Many firms sell adapters for 4 prong sockets to use the overhead heater tubes. These can be heated by using external wires to the heaters in the tester.

No Directions for Neutralizing

No directions for neutralizing radio sets or for aligning condensers will be given here since the purpose of this article is to tell how to construct the tester. In order to neutralize successfully you must have an audio frequency oscillator. It utilizes the 60-cycle supply for modulation, is very efficient and takes up very little room. Fig. 5 is the circuit. It derives its filament current from a "C" battery in the tester. The plate voltage is 110 volts A.C. The drawing is self explanatory. The plate voltage can be secured from a D.C. source such as an eliminator; or "B" batteries if one is handy. In that event the modulating frequency is controlled by the value of the grid leak. The variable condenser used is a Remler "Midget" 23-plate. The other fixed condensers are employed to increase wave

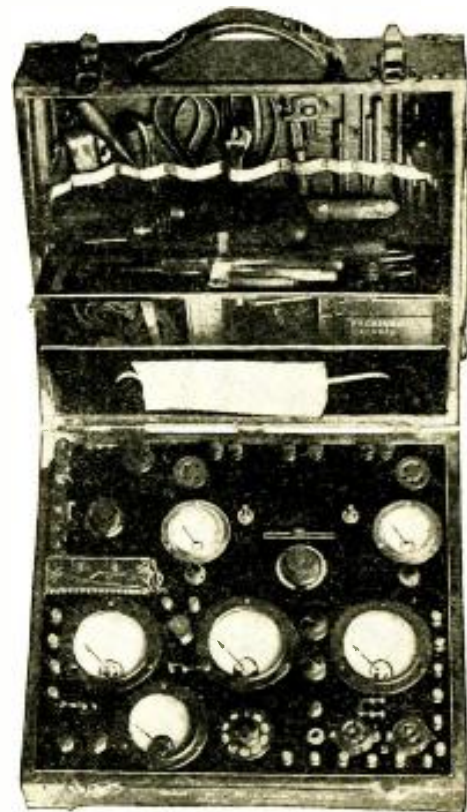

Fig. B
The complete tester is shown in this illustration. The compartments for tools and parts have covers of sheet steel, retained by chains.

to change the circuit so as to provide a means of testing screen grid tubes and supplying cathode voltages. A phone tip jack was placed on the panel to provide connection to the control grid of screen grid tubes.

Fig. 9 shows how the dial on the bi-polar switch is marked. These dials are so arranged that a piece of paper bearing whatever designation is desired, may be inserted.

Layout of Parts

Fig. A gives the layout of the various units in the complete carrying case, that is, the bottom compartment only; and the top compartment or cover of case contains all the necessary tools and parts, such as wire, grid leaks and condensers, several sizes of fixed condensers, assortment of bolts, nuts, washers, solder, etc., required in every day work.

Neutralizing Adapter

Fig. 12 shows one of two adapters which constitute a very important part of the complete tester and is used when neutralizing sets. This adapter permits taking out the original tube and placing the 4- or 5-prong adapter in the socket and replacing the tube again, in other words, to neutralize the set with the original tube in its proper place. After the stage is neutralized simply remove the adapter and insert the same tube into its socket. Two adapters are provided, one is of the four prong type and one is of the five prong type. These two will suffice for all kinds of sets exclusive of the top-heater type. These are easily neutralized by simply removing one filament wire.

The Aligning Tool

The illustration in Fig. 13 shows another tool that is worth its weight in gold. It is an aligning tool, and consists of a bakelite

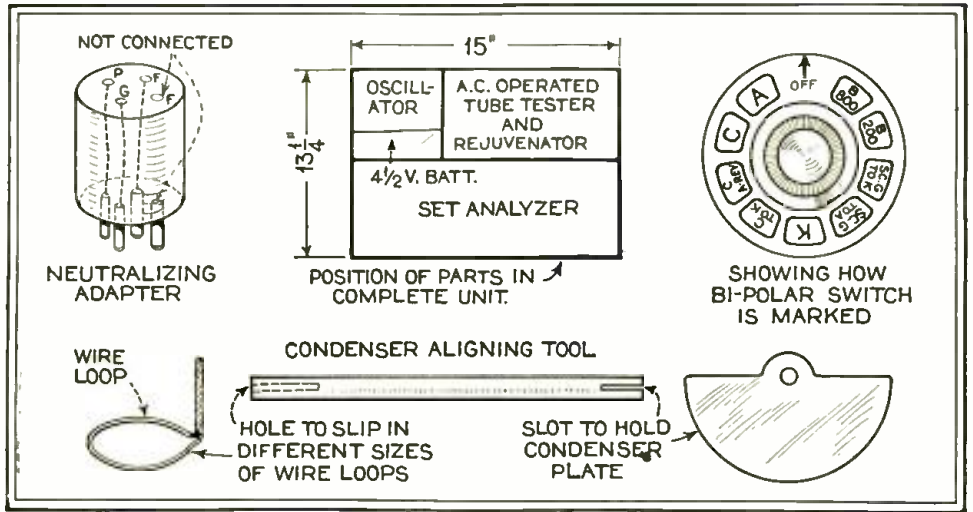

Fig. 9 (upper right). The markings on the bi-polar switch. Fig. 12 (upper left). Adapter to be used when neutralizing. Fig. 13 (lower half). Aligning tool for balancing variable condensers. Fig. 14 (upper center). Placement of the electrical equipment of the tester.

rod 1/4- or 5/16-inch in diameter and 6 or 8 inches long. A slot is cut at one end to hold an old condenser plate. Do not fasten the plate to the rod as it will not fit with equal ease in all receivers. The condensers should be aligned with the shield (if one is used) around condensers or at least in its regular position. If left off entirely it will alter the condenser balance adjustment, especially at the lower end of the scale. The other end of the rod has a 1/8-in. hole bored into it to a depth of 1 inch and into this is slipped a loop as shown in the drawing. I do not carry such loops, instead, a roll of bare No. 26 wire and loops as shown are made on the job. In view of the different sizes required this arrangement is preferred. The wire can be twisted into a loop that will fit over the RF transformer at

hand. In case some wire within the set interferes with the loop the latter can be made small and inserted inside of the RF transformer. Either method will produce the same result. As to their use after the set is aligned or if the set is considered to be out of alignment, the condenser plate is placed with the slot cut in the rod and one side of the plate is placed on the grounded side or stator plates of the tuning condenser. Then the plate is slowly tilted towards the other plate, thus increasing the capacity of the particular condenser and if the capacity was just right or excessive, the signal will decrease. If the signal increases it is a sign that the condenser capacity adjustment is less. After resetting the condenser, repeat the test. If the signal decreases it means that the condenser plate setting is right or excessive, and this can be checked by means of the loop described in a preceding part of this paragraph and in drawing 13. This loop acts as a shorted turn and decreases the inductance of the coil. It should be slowly put inside the coil or around the outside. If the signal increases the condenser adjustment must be corrected. If, however, the signal decreases it is a sign that the capacity setting is right or too low. The former test showed it was not too low, hence the check shows that this particular condenser is satisfactorily adjusted. The same test should be applied to the remaining variable condensers without changing their setting on the tuning dial.

The condenser plate test can be made on the side of the coil as well as on the condenser itself. Placing the plate adjacent to the side of the coil will also increase the capacity of this particular circuit, which is the equivalent of placing the plate adjacent to the condenser stator. This test should be made on both a high wave length as well as a low wave length to see if the condensers are correctly aligned throughout their full capacity range.

Fig. 11 shows the Sterling R510 tube tester and rejuvenator circuit, with the modifications described. It can be purchased and removed from the metal case and mounted upon a rubber or bakelite panel. If the constructor wishes he can construct a tester as shown. The transformer can be any toy step down unit with

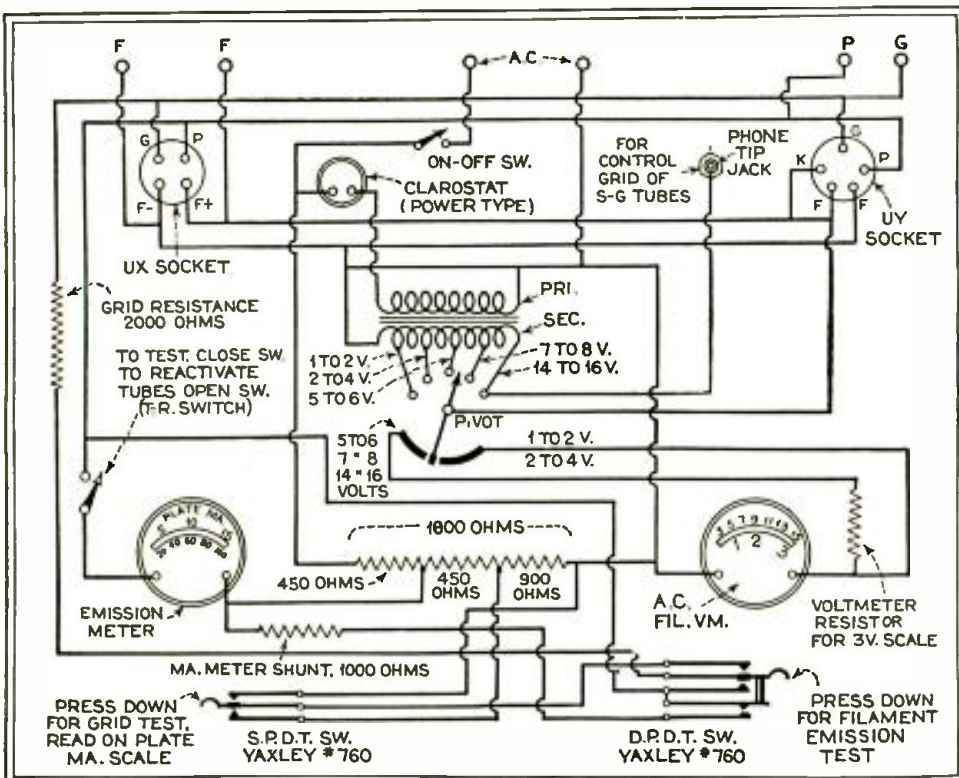

Fig. 11

Schematic circuit of the tube rejuvenator and tester. Panel size is 6 1/4 x 11 inches.

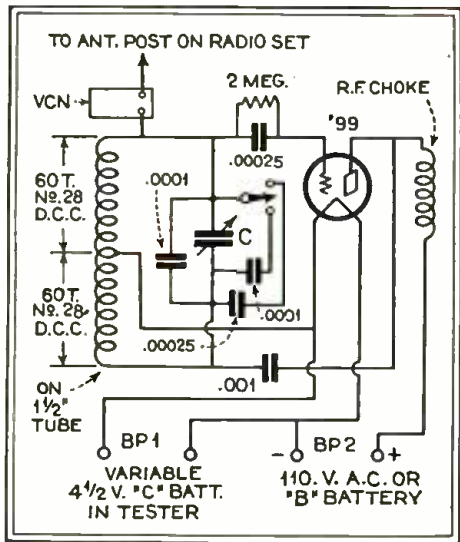

Fig. 5

Schematic of the circuit driver used for neutralizing receivers: C is a midget, of 23 or more plates. Choke has 100 turns of No. 28 D.C.C. wire on a 1/2-inch core.

taps so as to afford a complete voltage range in conjunction with the adjustable resistance. The available voltage range is from 1 volt for the WD11 tubes to 15 volts for the Kellogg tubes. The switch on the transformer is used to cut in the AC voltmeter resistance with bottom contact and to cut in the transformer taps with its top contact. The switch handle protrudes through the panel.

Emission Meter

The emission meter is a 0-15 milliammeter with the emission value marked on scale as shown. 35 is the equivalent of 5 MA; 75 is the equivalent of 10 MA and 100 is the equivalent of 15 MA. The AC filament meter is a double range 0-3-15 volts and can be bought with the external resistance. The two switches to the left and right of the center of panel are the "off" and the "on" switch. The left one is the "test" and "reactivate" switch of S. P. S. T. type. The bottom switches are of the jack type.

To Operate Reactivator

D.C. tubes, types '99, '20, '01A, '00A, '40, '71, '10, '13 are the only ones which may be reactivated. Before placing the tube into the socket turn on the current and set lever switch to the desired voltage and adjust to the exact value with the clarostat. Set the right hand switch to "on" and the left hand switch to "react." Consult table below for time schedule and insert tube. Time the reactivating flash voltage for exactly 30 seconds and at the end of 30 seconds shift lever switch to aging voltage and readjust with the clarostat. Age tube for 10 minutes. Although some may be O. K. in 2 minutes it is a good policy to throw switch to emission and test the emission to see how the tube has developed. Compare the emission readings with table and when satisfactory turn off the current.

If tube does not come up in 10 minutes continue aging from 20 minutes to 1 hour.

Tube Types	Filament Volts	Filament Emission	Flash Voltage	Aging Voltage
'99	3.3	15-25	12	4
'20	3.3	20-30	12	4
'01A	5.0	40-60	16	7
'00A	5.0	40-60	16	7
'40	5.0	40-60	16	7
'71	5.0	50-70	16	7
'10	7.5	40-70	16	9

Grid Swing Test

To test tubes for mutual conductance set switch to desired operating voltage and adjust switch to "test" position. Read the plate current on meter. Then turn lower left switch to "grid test" position ("down") and again note plate current reading. Subtract one reading from the other. The greater the remainder the better the tube as an amplifier since this test gives the change in plate current for a change in grid voltage. A good tube will vary about 4 to 6 mils—'99 and '11 and '12 type tubes show a variation of 2 to 2.5 mils. A fair reading for the average tube would be 3 to 4 mils. A poor tube would show a difference in plate current of 1 to 2 milliamperes.

Outside Voltage Supply

By inserting the 5 wire cable lead in sockets of the Sterling tester or by using outside wire connected to the binding posts all AC voltages from 1/2 to 16 or more volts are available for any special work.

Fig. 5 shows optional "B" supply. In oscillator the small fixed condenser is bolted to top of small Remler variable condenser and it completely hides the variable. One coil is wound over winding with empire cloth so parts will not rub through cotton insulation and cause a short.

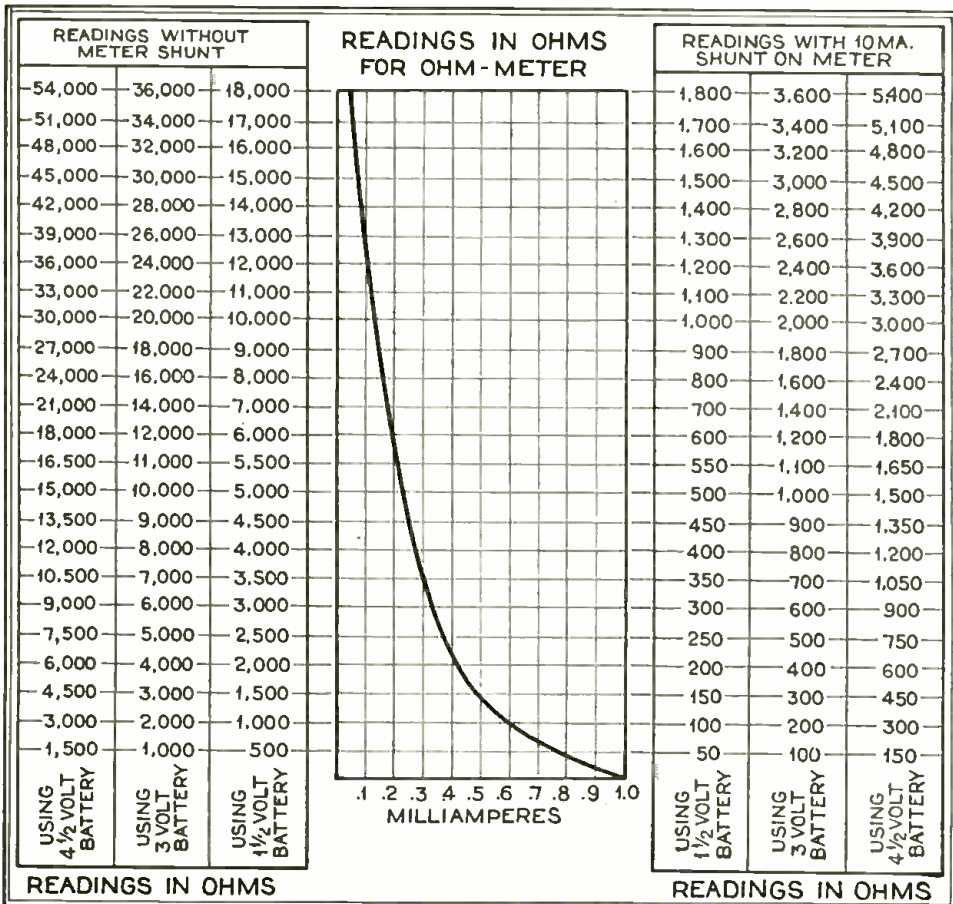

Fig. 6

Table for use with the ohmmeter: with a 1 1/2-volt cell and no shunt, the resistance values in ohms will be as follows: 0.1-ma., 13,500; 0.2-ma., 6,000; 0.3-ma., 3,500; 0.4-ma., 2,250; 0.5-ma., 1,500; 0.6-ma., 1,000; 0.7-ma., 643; 0.8-ma., 375; 0.9-ma., 166; 1.0-ma., 0.0.

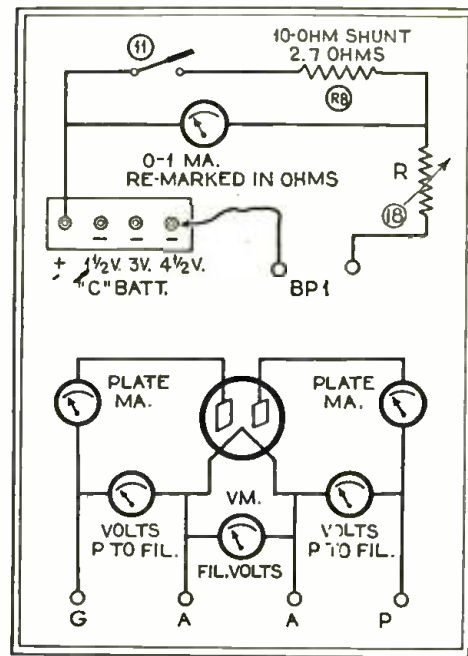

Fig. 2 (above)

An unknown resistance is connected across BP1 of the ohmmeter; R is a "power-type" variable resistor.

Fig. 4 (below)

An '80-type rectifier may be tested in all manners shown.

BRUNSWICK MODEL 31 COMBINATION RADIO AND PANATROPE

In this receiver a radio-record switch, Sw2, cable and input transformer, T4, are used, in order that the low-impedance of the pick-up may be matched with the relatively high input impedance existing in the primary of T1.

Referring to the parts layout sketch, units TC1, TC2, TC3 and TC4 are trimmer condensers in shunt to the tuning condensers but not shown in the schematic circuit.

This receiver is in three sections: The R.F. chassis, the "SPU" (socket-power-unit) chassis and the dynamic reproducer. Field current for the latter is supplied by the SPU. Note that operation of the receiver should not be attempted unless either the field coil of a dynamic or a 600-ohm resistor is connected across the terminals for the two "field" leads; this resistor must be capable of carrying 100 ma.

To facilitate service, the R.F. chassis and SPU chassis are bolted to a single mounting board which, in turn, may be removed from the cabinet by removing retaining bolts at the rear of the mounting board.

For hum control, two filament shunt resistors, R9, R10, with variable center taps, are provided on the SPU chassis. R9 is adjusted first and then R10. If R10 appears unresponsive, try other '27s at V4 and V5. Abnormal hum may be due to one or more of the following causes: (1) One or more R.F. stages oscillating; (2) low-emission tube, particularly a '45 or the '80; (3) open filter or by-pass condenser; (4) open grid lead in R.F. or audio amplifier; (5) center arms of R9 or R10 not grounded or poorly grounded.

Abnormal hum, which appears usually on a strong local or nearby station and cannot be balanced out with R9 or R10, may be due to condition (1), above, and must be remedied before further adjustment of R9 or R10. At the factory, these receivers are neutralized for standard tubes, and the neutralizing screws then sealed with collodion to maintain adjustment. Before attempting to re-neutralize the receiver, it is advisable to test the tubes or try others; as an abnormal one may be the cause of circuit oscillation.

Additional checks on the possibility of R.F. circuit oscillators are these indications: Distorted reception of any or all stations—usually on the lower wavelengths; a whistle or squeal preceding the station being tuned in and not due to a two-station carrier heterodyne; motor-boating on all portions of the broadcast band.

Standard practice in neutralizing this receiver is as follows: Adjust an audio-modulated oscillator for 1400 kc. and couple it to the "long antenna" post of the receiver with a five-foot wire, one end of which should be wrapped two or three times about the oscillator coil. Tune in the oscillator signal on the radio to maximum volume, using both the tandem-condenser control and C5.

Then allow the receiver and oscillator to operate for about a minute (in order that the tubes may become thoroughly warmed up and "stable") and replace the first R.F. tube with a tube of average characteristics which is known not to cause oscillation in a receiver which has previously been

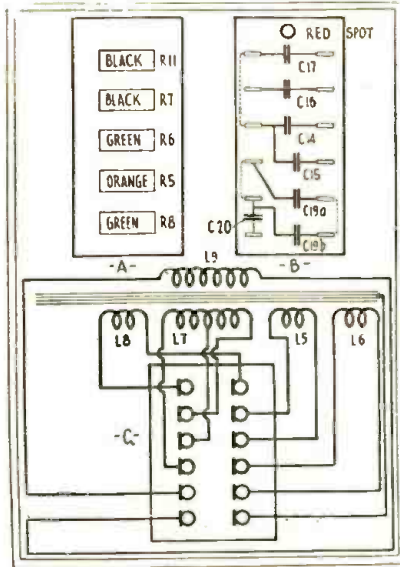

neutralized; this tube must have an open filament circuit. A fault into which some service men fall is to neutralize with one make of tube and then, after neutralizing, insert a different make—the circuit may then oscillate more than before.

Adjust C6 (see parts layout) for minimum signal. The signal intensity will be so great that an entirely silent point cannot be found.

Replace the neutralizing tube with the standard tube, and repeat performance for tubes V2 and V3; in each instance allowing

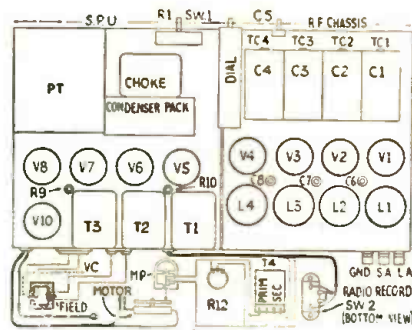

about a minute for the oscillator and receiver tubes to become stabilized.

If any difficulty is experienced in the neutralizing process, check supply potentials and the by-pass condensers. An open con-

denser may allow sufficient R.F. feed-back to the previous stage to make it impossible to find a good signal minimum. Also, a dummy tube that does not have quite the necessary constants may make it difficult to balance the circuits.

The normal line-current drain of this receiver is approximately 115 watts. The average voltages indicated at the terminals of the tubes are given in an accompanying table.

Tube No.	Type	Voltage			Plate Ma.
		"A"	"B"	"C"	"Normal"
V1	'27	2.5	150	12	5.5
V2	'27	2.5	150	12	5.5
V3	'27	2.5	150	12	5.5
V4	'27	2.5	45	0	3.4
V5	'27	2.5	145	9	3.6
V6	'45	2.4	240	27	30.0
V7	'45	2.4	240	27	30.0
V8	'80	5.0

The values of the parts in this receiver are as follows: R1, 25,000 ohms; R2, 800 ohms; R3, 35,000 ohms; R4, 2 megohms; R5, 35,000 ohms; R6, 100,000 ohms; R7, 3,500 ohms; R8, 100,000 ohms; R9, 25 ohms; R10, 25 ohms; R11, 4,000 ohms; R12, 70 ohms. The capacities used are as follows: C9, .00015-mf.; C10, 0.2-mf.; C11, 0.2-mf.; C12, 0.02-mf.; C13, .002-mf.; C14, 1.5-mf.; C15, 1-mf.; C16, 0.25-mf.; C17, 0.5-mf.; C18, .00025-mf.; C19, 1.75-mf.; C20, 1.0-mf. The positions of L1, L2, L3, L4, L5, L6, L7, L8 and L9 are obvious.

Trouble with the Panatrope portion of the receiver may usually be classed as: (1) Magnetic pickup MP out of adjustment; (2) Sw2 out of adjustment; (3) motor speed irregular.

There are four points on the turntable unit which require lubrication: (1) Upper turntable bearing; (2) lower turntable bearing; (3) governor bearing, weight end; (4) governor bearing, worm-gear end. To operate noiselessly and at constant speed it is necessary that the motor be kept in good condition. To remove the motor for oiling, proceed as follows: (1) Remove the record turntable by pulling it upward; (2) remove the four motor-securing bolts; (3) detach the motor leads from the cable in the cabinet and lift motor from cabinet. After this, all parts should be cleaned. Then, using a light-grade oil, proceed to lubricate the motor at the points mentioned above. This lubrication process should be followed every six months.

A noisy turntable motor may usually be traced to: (1) Governor shaft bearings loose; (2) lamination loose in one or more of the four coils; (3) coil loose on its core; (4) defective spring in governor. If the speed is not constant, it may be due to (1) or (4), above. To tighten governor bearing, loosen set screw, push bearing gently toward center of motor and tighten screw. Do not force bearing in too far, or it may bind the governor shaft. (Be sure set screw of opposite bearing is tight.) Laminations may be pressed together by tightening the retaining bolts. If a coil is found loose on its core, force a small wedge of soft wood between coil and core, to prevent the coil from vibrating, and thus stop the noise. A bent or broken governor spring should be replaced.

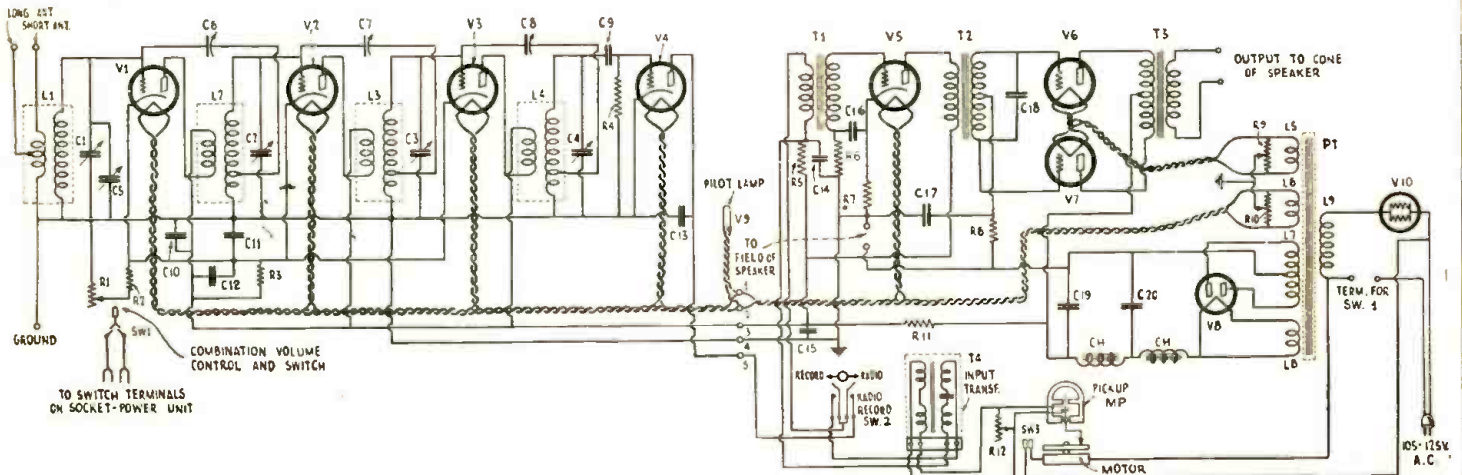

STEWART-WARNER SERIES 900

This receiver is so designed as to permit the use of aerials of widely differing characteristics. In addition to being adaptable to aerials of the usual type, it makes provision for use of the light-line, if satisfactory operation results when the R.F. input is taken from the light-line through C13. (Sw. 1 on tap L.). If the light-line is being used as the aerial, reversing the line plug may improve reception.

Volume control is effected by varying R2. This varies the grid-bias potential on tubes V1, V2 and V3. The first tube V1 has a tuned input and its synchronism in relation to the other tuned circuits, is accomplished through a trimming condenser, C5, controlled from the panel.

The detector output of this receiver may be tapped to any external equipment, by connection to posts provided on the rear of the receiver. Specifically, it is intended to make convenient the operation of television equipment by connecting to binding posts BP1 and BP3. Also, the detector input may be tapped for operation of a phonograph pickup, by connection to posts BP1 and BP2. There is no switching device for disconnecting the pick-up; for its leads would introduce a capacity that would impair the "phase" conditions, (resonance of the stages) of the set; consequently, the pick-up connections must be removed from the receiver when only radio reception is desired. The amplification of the detector tube is obtained when the pick-up is connected to posts BP1 and BP2.

The circuit used in this receiver is of a neutralized type, and is specifically called a "balanced-bridge" connection. (Changing tubes of the same type does not disturb the circuit balance.) Before attempting to re-balance the R.F. circuits, in the event of circuit oscillation, it is advisable to make certain that the ground is a satisfactory one. It is convenient to do this by connecting a voltmeter between the ground wire and one side of the 110-volt light-line. The maximum voltage reading obtained in this manner should be practically the same as the reading obtained by connecting the meter across the light-lines. Connection to aerial and ground is obtained through two leads: one black, for ground, and one blue, for aerial. Compensation for aerial variation is obtained by adjustment of switch Sw.1; which taps the primary of the input R.F. transformer L1.

In the earlier sets of this series, condenser C26 (next R9) was omitted, and a fixed center-tap resistor used instead of the variable R7. These two changes were made to reduce hum. Should one of the earlier receivers produce an objectionable hum, the set may be brought up-to-date by installing the variable resistor and condenser. (A "No. 66058" bracket is used for holding this unit.)

This receiver is designed to use either a magnetic or a dynamic reproducer; the field winding of the Stewart-Warner dynamic has a D.C. resistance of approximately 1,800 ohms. There is no transformer in this dynamic reproducer; the secondary of the output unit T3 matches the constants of the (12-ohm) speaker voice coil. A 4-connection

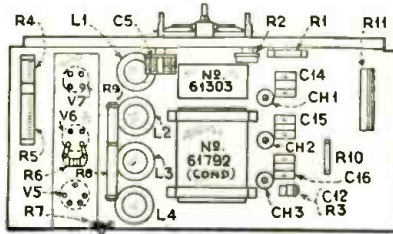

receptacle is provided for the dynamic reproducer; but magnetic reproducers connect instead to tip-jacks. The "B" voltages, which are disturbed when the dynamic reproducer field coil is removed from the circuit are equalized by load resistor R8; which is placed in shunt with the high voltage D.C. when the "link" is connected to the two binding posts shown at the upper right of the

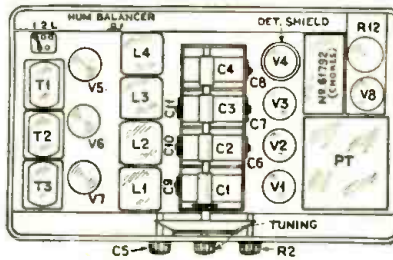

schematic circuit. Magnetic, and other makes of dynamic reproducers connect, as shown, from plate to plate of the power tubes.

At a line voltage of 110, the primary of PT should receive about 88 volts. When making any changes in the receiver connections or parts, it is well to watch the regulator R12. If it heats to a visible red, the plug should be pulled and circuit checked.

The parts of this receiver may be duplicated for service replacements by using the code numbers included in the following data: Units C1, C2, C3, C4, C6, C7, C8, C9, C10 and C11 constitute a complete assembly, No. 61,055—complete with bracket, No. 61,933; C5 is No. 60,955; C12, 38,261; C13 of .0001-mf. capacity is included in the shield can of PT; C14, C15 and C16, of .006-mf., are each 61,469; C17, .002-mf., 61,470; C18, 1.5 mf., 600-volt rating and C19, 2 mf., 400-volt rating are 61,303; C20, 0.5-mf., 400-volt; C21, 1.0-mf., 400-volt; C22, 0.5-mf., 400-volt, C23, C24 and C25, 0.25-mf., 200 volt, constitute, with two choke coils, filter bank 61,729; C26, 1.5-mf., 66,059. The resistors are, R1, 800 ohms, 61,830; R2, 60,000 ohms (max.), 61,557; R3, 1 meg. 61,590; R4, 2,400 ohms—R5, 850 ohms—constituting unit 61,839; R6, 20 ohms, 61,648; R7, 20 ohms, 66,060; R8, 10,000 ohms and R9, 5,500 ohms constitute unit 61,665; R10, 75,000 ohms, 61,559; R11, 7,000 ohms, 61,833; R12, line ballast, 61,868. Power transformer PT is 61,888; L1, 61,803; L2, 61,804; L3, 61,805; L4, 61,806; Ch1, Ch2, and Ch3, 61,405; T1, 61,914; T2, 61,915; T3, 61,916. For the pilot light V9, a 2.5-volt lamp is used.

All connections in this receiver are gold-plated; copper is used for shielding. The line-voltage ballast R12 is designed to equalize line voltages between the limits of 100 and 130 volts. The R.F. transformers are checked at three wavelengths from the output of a crystal-controlled oscillator at the factory; little likelihood that they are not in exact balance with each other, should the tuning circuits not "phase" exactly.

In this receiver the plate D.C. supply for the set is fed through R.F. chokes, Ch1, Ch2 and Ch3. Resistors R4 and R5 are wound on one form.

Units which might be subject to occasional replacement are easily removable from the set chassis. Filament leads are twisted pairs.

The grid bias on the '27s is limited to a minimum value by R1; but R2 makes possible a maximum bias which is sufficient to give full control of the amplification obtainable from the receiver.

TABLE 1
(Readings with Jewell "Pattern 199")

Tubes	Volts "A"	Volts "B"	Volts "C"	Plate Normal	Milliamps.	
					Grid Test	Grid
V1	2.2	132	8.5	3.8	7.0	
V2	2.2	138	8.5	3.2	5.8	
V3	2.15	132	8.5	3.9	6.8	
V4	2.10	32	0.0	2.8	2.8	
V5	2.2	132	7.5	5.4	6.5	
V6	2.25	226	47.5	26.0	30.0	
V7	2.25	226	47.5	26.0	30.0	
V8	4.7	

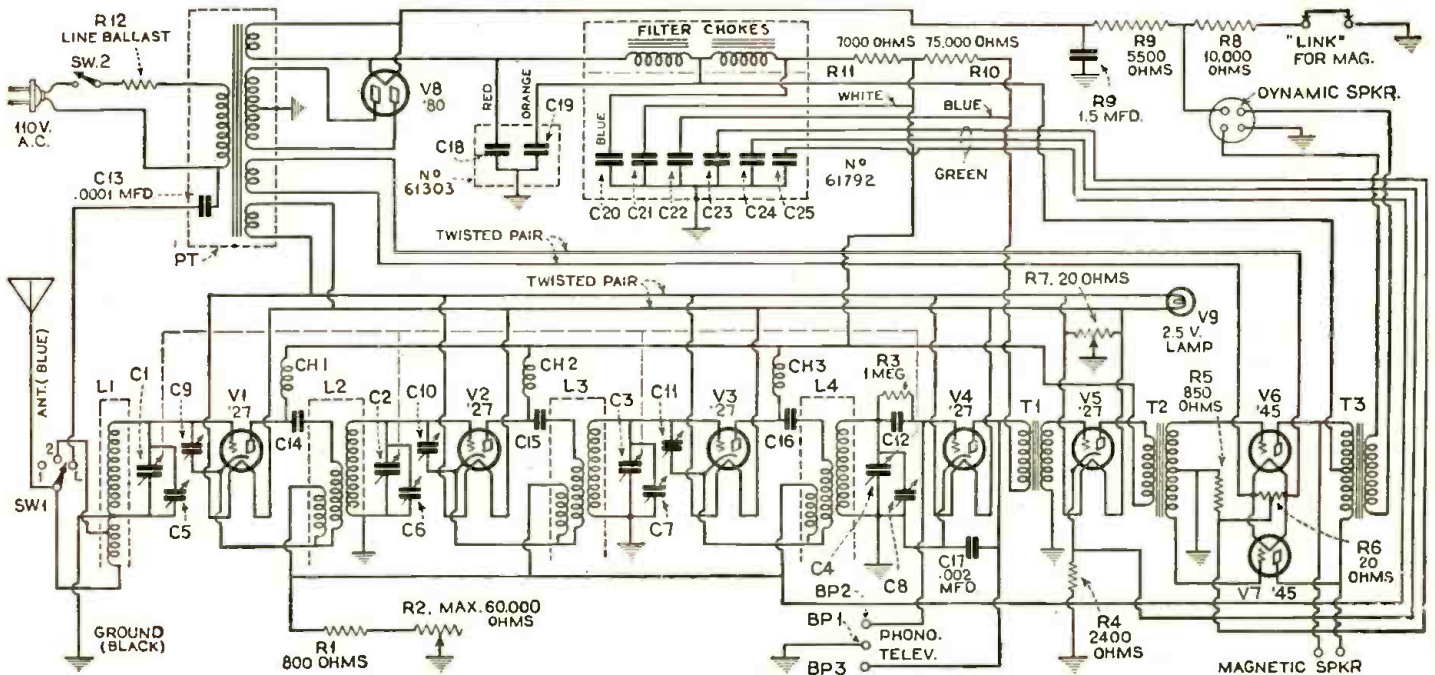

The Service Man's Open Forum

EXAMINATIONS FOR SERVICEMEN UNSATISFACTORY

A GENERAL examination for all-around radio service men is nowhere near the solution to our present situation. It would be impossible to give an intelligent examination that would qualify one man to service all makes of radio apparatus. **WE DO NOT HAVE A SET STANDARD.**

It is probable that the manufacturers have striven to eliminate the general Service Man, by excluding all but their immediate tradesmen.

The solution ought to be in ranking professional Service Men under rigid examination by the manufacturer; to service only that apparatus with which he is immediately associated.

This part-time spirit, jack-of-all-trades idea, will not work in radio service, any more than it would in any other trade.

JOHN E. CRANN,
Pittsburgh, Pennsylvania,

BETTER AS A SIDE LINE?

I LIKE RADIO-CRAFT, also your registration idea, providing it will bring about a better understanding between the manufacturers and the Service Man.

Too many manufacturers, when asked for the circuit of the latest, do not reply; or else say that they furnish them only to dealers.

My radio knowledge has been gleaned from magazines, books, etc., and six years' experience in set building. During the last three years, I have constructed over a hundred sets of one circuit alone; namely *Radio World's* "Diamond of the Air."

Since the advent of the "all electric" two years ago, I have discontinued building and devote my spare time to servicing entirely.

I have a car and testing equipment of my own make, which I have found adequate for nearly all occasions.

My motto has been to fix the set on the spot if possible; which, of course, requires quite a large supply of essential parts on hand. But I find this method makes friends, and I am sure of another call; and also a recommendation to someone else in need of radio service.

I have thought seriously of accepting a position as a Service Man; but my present salary in another line of work is considerably larger than I have yet been offered in radio service work.

Although I can't help but think that, if some of the boys employed by dealers are "service men", I am really and truly a "Radio Engineer."

MALCOLM F. GRISWOLD,
Chicago, Illinois.

THE SET OWNER PAYS FOR THE MANUFACTURER'S SECRECY

THE crying need in our work (servicing) for 1930 and any other time is schematic diagrams of the various receivers on the market.

RADIO-CRAFT is doing a wonderful work and living up to its name in this respect in its October issue. Keep them coming; and the future issues of RADIO-CRAFT will become a permanent reference of inestimable value to the service man.

Many manufacturers, it seems, are averse to "giving-up" their trade secrets (in this case, the secret being their circuit). This viewpoint is at first glance not unreasonable. After working months—perhaps years—to get out something good, why broadcast the result of all this labor and expense? That would appear to be "poor business." On the other hand, however, isn't this attitude somewhat silly? Who desires the details of anything, need only take the necessary time and application to trace out the "secret" and he can have it.

I have spent four to five hours' time tracing a "hook-up" and making a schematic diagram of a receiver that I was repairing. At the end the manufacturer had nothing on me as far as his receiver went; but I had put in a lot of time finding out what I must know to service the set intelligently; and the owner, his (the manufacturer's) customer, paid me for the time I consumed. If I had had this information ready to hand, the cost would have been nothing, comparatively speaking, to what it was; and it would not have left the "dark-brown" feeling in the mind of the customer against that particular set that it did.

In testing out for certain phases of trouble, it becomes necessary to sever certain joints to "break" the continuity of the circuit; and, unless there is a schematic diagram at hand, it is a haphazard procedure. One is often not sure that the test circuit is isolated and, until this condition obtains, you do not KNOW any more than you did before you started. If this is attempted without a diagram, you will have half the joints on a receiver unsoldered before you know it; and in the end find you have "broken" a number of joints that it would not have been necessary to break.

E. S. MOORE,
Somerton, Philadelphia, Pa.

DON'T BLAME THE TUBES TILL YOU KNOW

WE publish the following interesting article by the Sales Manager of the Arcturus Radio Tube Company, of Newark, N. J., without editorial comment. Our readers, no doubt, will be very much interested in this short article.—Editor.

Editor, RADIO-CRAFT:

Permit me to quote from your booklet, recently issued in connection with RADIO-CRAFT: "Today, in most towns, and in city neighborhoods, the SERVICE MAN has a clientele who rely exclusively upon him. He has years of experience, and his word carries weight with the buyers of radio goods, whose own knowledge of radio is limited to the consumer advertising in newspapers and magazines, who are bewildered amid the competing claims, and who rely upon their own judgment only as regards the decorative appearance of the receiver's cabinet. For technical advice, they depend upon the SERVICE MAN."

The Service Man, like the doctor, should preserve the confidence of his clientele, and not so readily accept the course of least resistance.

Many Service Men answer a call by sending a messenger with a set of tubes. They are convinced, before they start, that tubes form the source of trouble.

Service Men were essential before A. C.

(Continued on page 415)

Opportunities for Service---An Announcement

TO make this magazine of additional benefit to Service Men, RADIO-CRAFT announces a new feature, of which advantage may be taken, free of charge, by any Service Man who has enrolled himself in the NATIONAL LIST OF RADIO SERVICE MEN (by filling out in full the blank which is printed in every issue of this magazine). We will print short notices of the same nature as those which follow; and will forward to the writer of any of them the replies which may be addressed to him (by the number given) in care of RADIO-CRAFT.

We must reserve the right to condense all letters into their most essential details; and we urge all our correspondents who use this service to be as concise, though thorough,

as they would be in the composition of a paid advertisement which would cost them several dollars.

It is desirable that references be given in all letters seeking employment, etc.—not for publication, but in order that RADIO-CRAFT may verify the statements made, if requested to do so, by parties interested in replying to the advertisement.

We cannot publish under this heading any advertising of a commercial nature—for the sale of goods, or instruction, etc.; or for an employment agency. We cannot publish offers of general servicing for the public, or general representation of a manufacturer in a district. For the former, local advertising mediums are available, and as to the latter, a manufacturer requesting such in-

formation will be given it directly from the files of the NATIONAL LIST OF RADIO SERVICE MEN. Announcements seeking or offering regular employment, however, will be accepted under the conditions stated above.

The following requests have been taken from recent letters accompanying enrollment blanks; and their nature will show what is meant. Service Men seeking employment should give, at the beginning, the important details which an employer will first ask; and anyone offering employment to a Service Man should be equally specific.

The writers of any of these requests may be addressed as Opportunity No. _____ (number given below), in care of RADIO-CRAFT, 98 Park Place, New York City.

(Continued on page 415)

Men Who Made Radio—Heinrich Hertz

THE FIFTH OF A SERIES

ON New Year's Day, 1894, a world troubled by wars, social and financial conflicts, with its attention concentrated upon the ambitions of empires, gave little heed to the deathbed of a young man of science whose brilliance of intellect was well matched by his devotion to the advancement of knowledge, and his nobility of spirit. A few scientists knew—but none fully realized at the time—that his genius had given to mankind what is virtually a sixth sense.

Heinrich Rudolph Hertz, born at Hamburg, Germany, on February 2, 1857, pursued as a youth his technical studies, with the purpose of becoming an engineer. The fascinating nature of scientific research, particularly in the field of electricity, where the misty outlines of new worlds were looming on the horizon, inclined him toward a career of discovery. "I would rather," he wrote to his parents in October, 1877, "be a great scientific investigator than a great engineer; but would rather be a second-rate engineer than a second-rate investigator." During the remainder of his short span of life, his ambition was rewarded.

In the following year, his investigations into the subject of "electric inertia," as certain phenomena were then described, won for him a prize, which he elected to receive



in the form of a gold medal from the scientific society propounding the theme for investigation. In 1879, as an assistant at the Berlin Physical Institute, Hertz's ability attracted the interest of the great physicist

Helmholtz, who urged him to study the interrelation of magnetism and electrical charges. His doctor's degree was awarded for a thesis on "the distribution of electricity over the surface of moving conductors."

Appointed professor of physics at the Karlsruhe Polytechnic High School (a term implying, in Germany, an educational institution of collegiate qualifications), Hertz carried out there, under great handicaps from the limited size of his laboratory and the deficiencies of his equipment, the experiments which were to rank him among the immortals of science.

As a physicist, however, his work was not restricted narrowly to the field which is forever associated with his name. We find among his earlier published papers an inquiry into "the contact of elastic solids," brought up by the practical problem of surveying the earth's surface; others on the evaporation of liquids, and the design of a new hygrometer—which occasioned a dutiful letter to his parents, suggesting that the device be employed in their home for the regulation of its humidity to a healthful degree; a study in 1883 of the cathode ray, which he determined to be "a phenomenon accompanying the discharges and having

(Continued on page 410)

Attention: Radio Service Men

RADIO-CRAFT is compiling an international list of names of qualified service men throughout the United States and Canada, as well as in foreign countries.

This list, which RADIO-CRAFT is trying to make the most complete one in the world, will be a connecting link between the radio manufacturer and the radio service man.

RADIO-CRAFT is continuously being solicited by radio manufacturers for the names of competent service men; and it is for this purpose only that this list is being compiled. There is no charge for this service to either radio service men or radio manufacturers.

We are hereby asking every reader of RADIO-CRAFT who is a professional service man to fill out the blank printed on this page or (if he prefers not to cut the page of this magazine) to put the same information on his letterhead or that of his firm, and send it in to RADIO-CRAFT. The data thus obtained will be arranged in systematic form and will constitute an official list of radio service men, throughout the United States and foreign countries, available to radio manufacturers. This list makes possible increased cooperation for the benefit of the industry and all concerned in the betterment of the radio trade.

NATIONAL LIST OF SERVICE MEN.

c/o RADIO-CRAFT, 98 Park Place, New York, N. Y.

Please enter the undersigned in the files of your National List of Radio Service Men. My qualifications are as set forth below:

Name (please print)

Address (City) (State)

Firm Name and Address
(If in business for self, please so state)

Age Years' Experience in Radio Construction?

Years in Professional Servicing?

Have You Agency for Commercial Sets? (What Makes?)

What Tubes Do You Recommend?

Custom Builder (What Specialties?)

Study Courses Taken in Radio Work from Following Institutions

Specialized in Servicing Following Makes

What Testing Equipment Do You Own?

What Other Trades or Professions?

Educational and Other Qualifications?

Comments

(FEB.) (Signed)

Modern Sound Projection

A Veteran of the Projection Room Describes Past and Present Methods, and Outlines the Possibilities and Requirements of the Jobs which "Sound" Projection has created for Radio Men

By RICHARD CARMAN

OPPORTUNITIES to capitalize technical ability, particularly of the kind possessed by the radio Service Man and by radio experimenters of wide experience—such particularly as those who have studied television, for instance—have been remarkably multiplied in the past few months by the enthusiasm with which the public has greeted the advent of "Sound" motion pictures. There is no doubt that during the next few years they will entirely supersede the "silent" variety; and the enormous extension of their installation calls for ever-increasing numbers of technicians—engineers, operators, service men, etc. At the present time, the great electrical companies which have developed the various types of "sound" picture installations are looking forward confidently to television, in the theater, if not in the home, within a comparatively short time.

On page 384 of this issue is quoted a definite prediction to this effect, made by one of the principal technicians of the electrical industry.

All these things make opportunities for the enterprising technician and, since radio experience and radio methods have guided the "Sound Projection" engineers, they will be valuable assets for the radio Service Men who enter this allied field. As a matter of fact, we know that many readers of RADIO-CRAFT have already done so.

For that reason, a department devoted to *Sound Projection Engineering* has been established in this magazine; and will be so conducted that it will be of interest to those already in the new professions, as well as those who are desirous of fitting themselves for entry into this profitable field. This first article, by a projectionist of many years' standing, will serve to introduce the subject to the latter class among our readers; and will be followed by others of a more technical and educational nature. We recommend every radio Service Man, and every serious experimenter, to read it through carefully, and listen to the banging of Opportunity's knuckles on the door.—*Editor.*

SOUND pictures present a dazzling future to the ambitious technician—to the "Service Man" who wants to get into a new and rapidly growing technical field; to the "set builder" who wants to graduate into a situation where American ingenuity and a natural ability in things mechanical and electrical may be applied very profitably; to the "engineer" who wants to find greater expression for his knowledge of science in all its diversity. On the doors of all these men, Opportunity whangs mightily for attention.

Much has been written on the subject of Sound Projection. But it has been either "over the head" of the reader, or too impractical in treatment to be of much financial benefit.

In this, and subsequent articles, the writer will endeavor to make clear to the readers of RADIO-CRAFT just what the professions centering around Sound Projection have to offer, and what they require of those who apply themselves to this new field of extraordinary possibilities. He can explain best, however, by a brief resume of the history of the motion-picture operator and his duties; and the revolutionary changes which the past two years have effected; and by giving his readers a peep into the modern "sound" operating booth.

Necessarily, it must be realized that there is more to "sound projection" than merely turning a crank, focusing, changing reels and records, and jabbing replacement vacuum tubes in position. Before we can plunge into even the every-day technicalities, we must know those concepts that constitute the fundamentals of "sound" motion pictures.

A "Flash-Back"

In the parlance of the screen, let us run a "flash-back" to the olden time when the "nickette" was in its heyday. In those days, when five cents was the standard charge for a "moving-picture show," the "moving-picture operator" was without a doubt the hardest-working individual in the entire game.

Not only had he to run *the* machine, but he had also to chase over to the film exchange, select his reels and, later, return them. It also was quite usual to find him, in spare moments, shining brass, polishing windows, and perhaps selling tickets. Being blessed (or cursed) with an intelligence a bit above the average, it devolved upon him to see that the illuminating arcs outside the theater were kept in working condition.

When it came time for the show to start, he ducked inside the cubby-hole in which was housed the one (and only) machine. Changing reels meant a more or less patient wait by the audience until the requested "Just a few moments until we change reels" had elapsed. There was no electric motor to snap on; no speed control, to govern the various speeds required for the different types of action in the picture, or to "time" the picture with the music furnished by the orchestra in the pit. Speed was governed solely by the operator's mood and ambitious "cranking."

Winter or summer, he stood beside hot, spitting alternating-current arcs, drawing from sixty to a hundred amperes, and ground his picture through. There were no quiet direct-current powered arcs; no auto-

matic arc-controllers to feed the arcs correctly; no scientifically-correct, low-intensity or high-intensity parabolic reflector arcs.

Since those "good old days" the old booth has become a bit cramped; two new machines have replaced the old single one, and the operator is now in a position to run a "continuous" show without the tiresome wait for changing reels.

Direct current for the arcs, also, became available, and new lamp houses with parabolic-mirror reflectors gathering every possible ray of light and sending it to the screen, rather than wasting it on the inside of the lamp house.

Motors, with speed controls, and clutches, and countless added improvements, brought the motion-picture machine to the point where the man who operated it needed considerable skill and knowledge.

The demand for "Service" by the new and big theaters which were being built required, in some instances, six and even eight men on a single shift. The "projectionist," to be successful, had to be a clever showman, ready for any emergency, as well as a mechanic and an electrician. It was during this period he obtained his fundamental grounding in "optical trains," "lenses," and dozens of things all rolled up under one name and called Projection.

Up to the time of the first "talkie" he had gained much. His salary had mounted higher and higher, and he no longer carried his own reels. But still a great many producers regarded him and his booth as necessary nuisances.

The Older Attitude

Theaters were built, in which the very last consideration was the projection room; and, even then, the very least that could get by was good enough in all too many places. In fact, the writer knows of a case where a new theater was built without the architect's even providing for the booth! The booth equipment arrived several days before the opening date and then, and then only, did they even start to make a place for the booth. It was placed in the balcony by removing some of the seats.

Let us consider the mental attitude which surroundings induce in the projectionist.

The audience sees the picture, and other projected effects, while seated amid the most finished and luxurious surroundings that architects and artists can create. Now, if the projectionist views the same picture and effects framed by a dirty, oil-spattered, unplastered wall festooned with a serpentine maze of conduit, etc., can his standards of judgment be as high as those of the audience—no matter how conscientious he may be? Never!

This psychological stimulus of fine surroundings is a truly mighty force. *It is ample justification for the best finished projection suites that any architect can conceive.* The man who is not susceptible and responsive to these things has no place in the modern projection room.

And, at last, the producers and exhibitors have learned that the projectionist can either make or break a picture. No matter what expense has been incurred, what pride and care have been exercised in the production of the picture, or how wonderful the story and popular the cast, the projectionist holds it within his power to enhance or ruin it in his own theater.

It now develops that the projection booth, which started as an "ugly duckling," has become a real *sanctum sanctorum*, presided over by a highly skilled technician, the "Sound Projectionist."

The Advent of "Sound"

When motion pictures emerged from their prolonged mute infancy they created a completely new atmosphere in filmdom.

Equipment and personnel, almost overnight, had changed; strange contraptions which, to the uninitiated, seemed to be little else but a mass of sprockets, flywheels, chain drives, cables and what-not, taking up far more space than the old-time, simple machinery, had replaced the now obsolete "silent" equipment.

An insight into the major factors in sound reproduction will be gained from the following description of the two methods of sound pick-up most used to-day, and the processes that follow, to the time of actual "sound reproduction."

In the *disc* method of sound movies, called "sound-on-record," the audio current comes from an electrical reproducer ("phonograph pick-up") playing on a disc record; these records are similar to the best types of phonograph records, but with the exception that they are much larger in diameter, thicker, and run at approximately half the standard speed; this enables each record to play throughout an entire reel (approximately 1,000 feet of film), run at an absolutely even rate of 90 feet per minute, *the*

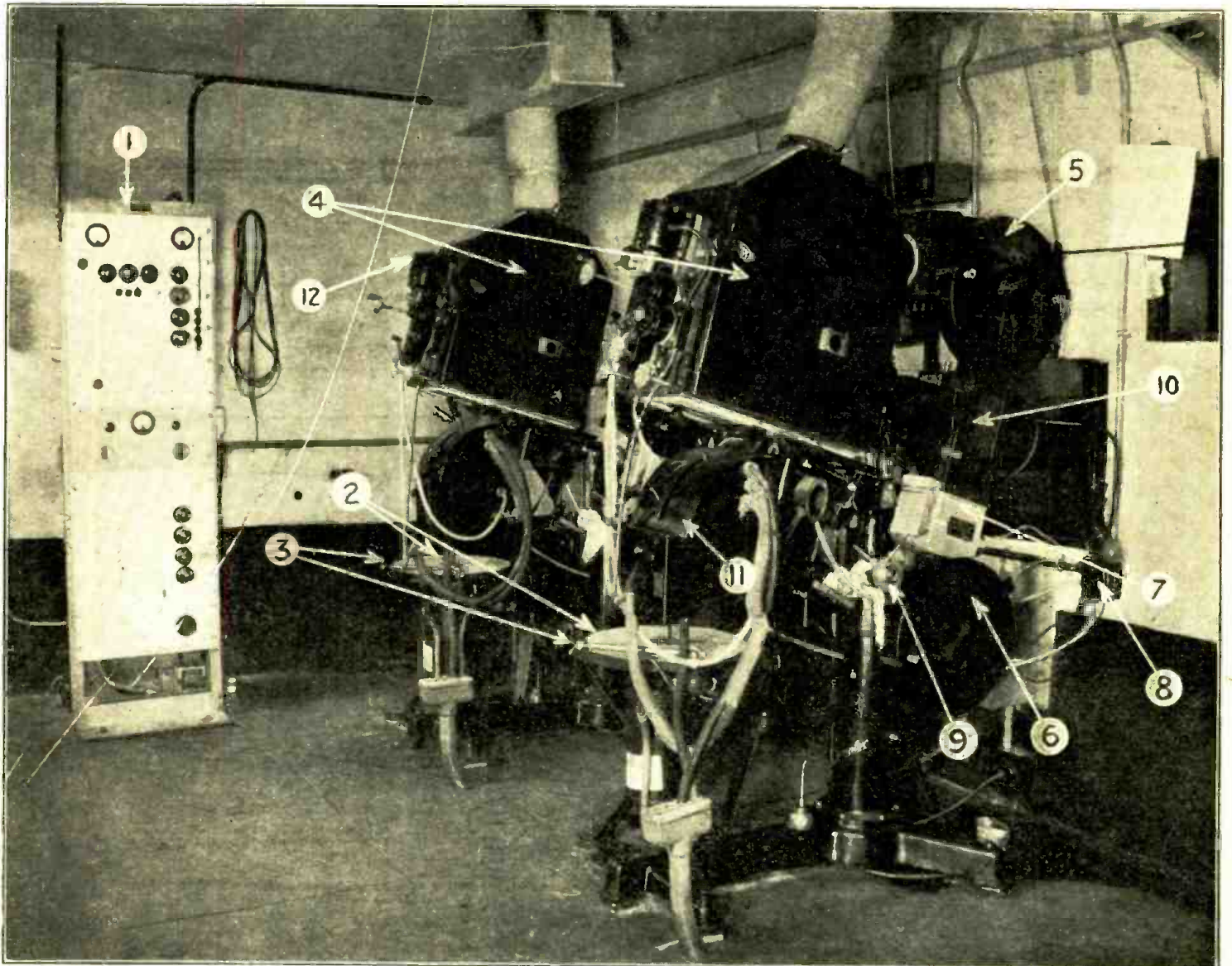

(Courtesy De Forest Phonofilm and Phonodisc.)

Fig. A

A modern projection booth, equipped for both disc and film sound methods; 1, amplifier panel; 2, turntable for Phonodiscs; 3, disc pick-up; 4, lamp house; 5, "loading" film magazine; 6, "take-up" film magazine; 7, Phonofilm "pick-up head"; 8, exciter lamp and film-sound switch; 9, machine switch; 10, projector head; 11, arc switch; 12, arc controls.

identical speed at which the picture was originally taken. The film used with the disc record, called "synchronized film," is similar to ordinary film, except that one "frame," or picture, at the beginning is especially marked to give the starting point corresponding to a marked starting point on the disc. The equipment running both the film and disc is mechanically connected and when once started correctly keeps the picture in exact "syne"—except when the discs prove defective or a piece of the film has been removed and not replaced by blank film of equivalent length.

With the *film* method ("sound-on-film"), the "sound record" consists of a band about one-eighth-inch wide, called the *sound track*, which runs down one side of the film and consists of microscopic light and dark lines whose spacing at each point depends on the pitch of the sound which was recorded at that moment. The difference in density of the lines depends on the loudness of the sound—that is, the greater the contrast between dark and light lines, the louder the sound. Such a film is called a "sound film," and is otherwise similar to an ordinary film.

After leaving the lower sprocket of the "projector head," the sound film enters the reproducing apparatus, where it passes over a sprocket that moves it along at an absolute, constant speed. A narrow, bright beam of light from an "exciting lamp" is focused

on the "sound track" of the film, through a system of lenses and a slit in an "aperture plate." The light which has passed through the moving film will then vary in intensity according to the variations of the lines recorded on the sound track. This light falls on a "photoelectric cell," which produces an electric current whose variations correspond exactly to those of the light, and therefore to the sound which was originally recorded.

The weak audio-frequency current thus evolved from the photoelectric cell, or the stronger current developed by the disc's electrical reproducer, passes along to the audio amplifiers—similar in principle to those used in audio-frequency stages of radio sets—and thence to the "horns" back-stage.

These are the tools necessary to enable the celluloid tape to release its talk, songs and tears for the entertainment of the theatergoer. A typical installation for "sound" motion pictures is shown in part in Fig. A.

Back to the "Lot"

Let us back-track to the *source* of our "sound" pictures, and note the enforced changes in the last few years.

There was a time when the "casting director" was able merely to glance at the prospective actors and actresses and shove them into the lot. But to-day they must

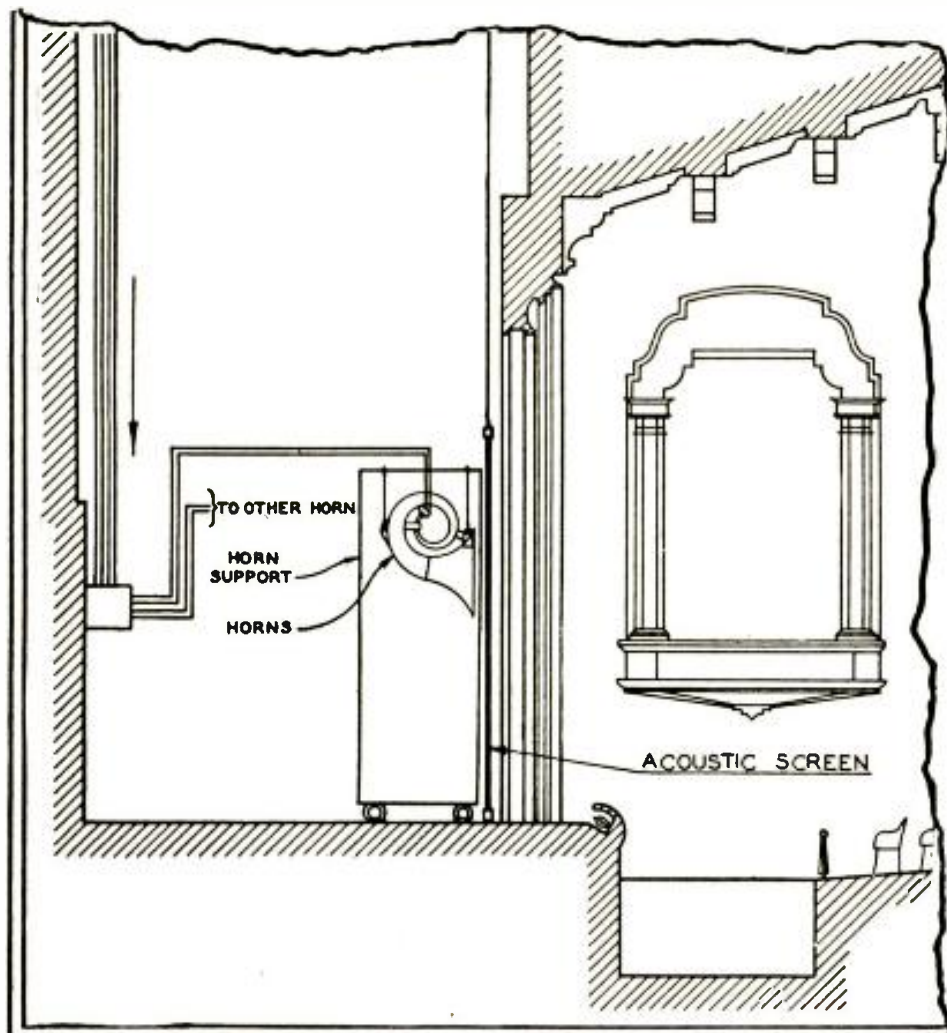

The general layout for sound motion pictures in a modern theater is represented here, and in the upper right corner of the next page, representing the relative positions of projection room and screen. The connections between the two are represented by arrows. The horns must be placed with regard to the acoustics of the theater.

GLOSSARY of "Sound Projection" Technical Terms

A

Acoustics—Sound conditions.

Aperture Plate—A plate on the projector head which masks off the outside dimensions of the picture.

Arc, High Intensity—An arc light consuming a comparatively large amount of current (from 50 amps. to about 130 amps.).

Arc, Low Intensity—A low-current arc (10 to 35 amps.).

Arc Controllers, Automatic—A device which maintains the proper distance between the two burning carbons.

C

Casting Director—One who selects the cast of actors for a motion picture.

Chain Drive—One type of mechanical connection between two rotating mechanisms.

Change-over—The act of changing over from one projector to another. A point in the picture where the action, or action and sound, on one reel is transferred to another reel to maintain continuity.

Clipping Room—A room where all film and sound records are inspected and selected for use or discard.

Clutch—A device used to disengage the motor from the projector. Sound installations usually eliminate mechanical speed controls and clutches, because of the standard speed now used for sound reproduction.

Condenser (Light)—A lens which converges the arc's light rays to the desired focus point.

Cranking—Rotating the film drive by hand.

Cut—A phrase used, in the studios, to indicate that all recording should stop; but, in projection work, indicating an actual cutting of the film.

E

Editing Room—A room where the film and sound are put together in "continuity" to form the story.

Electrical Pick-up—A device for converting the mechanical variations, in the phonograph-disc grooves, to electric current.

Exciting Lamp—A source of light for the sound-on-film method of reproduction. The focused beam of this lamp is transmitted through the film, in varying degrees of intensity, to the photoelectric cell.

F

Fader—A variable-resistor network used as sound volume control, and during change-over from one sound film to another.

Frame—An individual picture. Sixteen occupy one foot of standard film.

Film, Blank—Film upon which neither picture or sound has been recorded. Usually opaque.

Flash-Back—A repetition of a former scene, during the progress of a film, to denote remembrance.

G

Gain Control—A variable resistor network used to cut in or out as a master control of sound volume.

H

Horns—A term used to designate the sound reproducers. Often used even where the reproducers are of the cone type.

L

Lamp House—The housing for the light source (arc lamp).

Lens System (for Movietone)—A series of lenses which focus a tiny beam of light on the sound track, in the sound-on-film method.

M

Mike (Microphone)—The pick-up device used in the recording studio.

Motor Control Box—A box containing an electrical governing system to run the special motor of the projector.

Motor Speed Control—A device for regulating the speed (r.p.m.) of a projector.

O

Optical Train—A system of light "condensers" and lenses from the light source to picture screen.

P

Parabolic Mirror Reflector—A reflecting surface of parabolic curvature, usually made of heat-resisting glass. It concentrates the light from the arc, and sends it through the condenser, to form a "spot."

Photoelectric Cell—A light-sensitive unit that gives out current in proportion to the amount of light that reaches it from the exciting lamp, after the light has been "modulated" by the film's sound-track.

Picture Aperture—(See Aperture Plate.)

Pit—The space in a theater set aside for the musicians.

Projected Effects—Auxiliary projections (clouds, rain, lightning, silhouettes, etc.) used in conjunction with the regular picture to set it off or enhance its setting.

Projection Lens—A combination of lenses used to project the magnified picture upon the screen.

Projection Room—The place which contains the equipment for projection of the pictures.

Projector Head—The part of the projector (projection machine) containing the mechanism which moves the film past the aperture plate and actually makes the picture "move."

R

Retake—To record again either action, sound, or both.

(Continued on page 408)

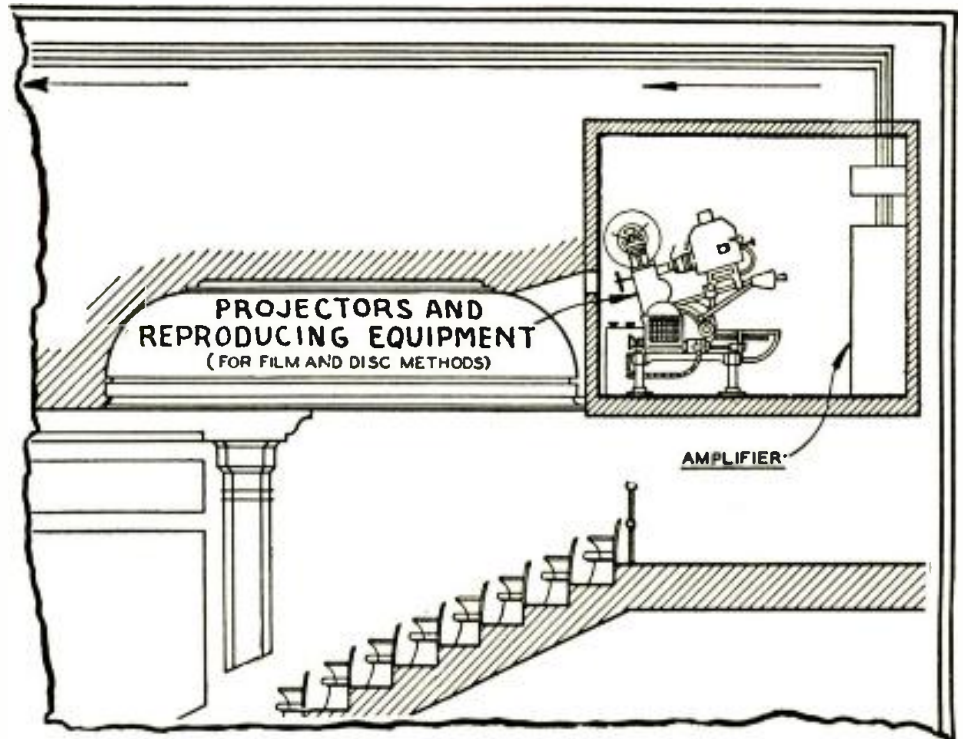

The projection equipment above is shown in its relative position to the sound and picture screens below, on the opposite page. The general layout of the apparatus may be compared with the photograph reproduced on page 377, showing detail. (Courtesy Electrical Research Products, Inc.)

have more than the former precious skin-deep beauty; they must be able to "sell" themselves to the audience vocally as well as visually.

To complete the illusion of reality, no single step is permitted to drop very far back of perfection.

The camera must run at a standard speed, in conjunction with the sound apparatus to which (usually) it is mechanically connected. Both must be operated from noise-proof booths. The cameramen themselves are greater technicians than ever before. They must be more exacting than ever; for a "retake" costs many times what it formerly did—in the "silent" days. The old-fashioned, noisy arc lamps used for illuminating the "sets" have been replaced by high-powered, silent incandescent lamps, to prevent feeding the hungry "mikes" with unwelcome sounds.

"Sound" has eliminated much that was usual routine in the old days. The director cannot shout his wishes to the performers; he must go over everything with them before hand, so that only a few motions on his part will later be needed. Now, he must be capable of directing their audible as well as visual performance.

In the "clipping room" and "editing room," the sound technicians must work in close harmony with the film operators. The sound must exactly match the picture. There is no more arbitrary cutting at any "frame" of the film; there must be a finish of the words, or whatever the accompaniment is, at the same instant that the corresponding action stops. Neither must be "cut" ahead of time; and both must be kept in absolute "Sync" (synchronism).

Reproduction can be no better than the recording and, if there is the least slip-up in any of the early stages, whether in "disc" or "sound-on-film," fidelity of reproduction is destroyed to just that extent.

Requisites of a Projectionist

The technical knowledge of the projectionist may readily be gained by any one who is ambitious enough to apply himself to whole-hearted study, but no one may be considered a projectionist until, by long and trying experience, he has learned the showmanship and artistry his position demands.

An engineer, employed by one of the biggest companies, may possess a very complete knowledge of the science and still not make even an average projectionist. A man might also be an excellent machinist and electrician without being a successful projectionist.

From the writing of the scenario, throughout the production stages of a picture, until its presentation, everything is done to catch and hold the fancy of the patron. If for any reason his interest is interrupted it lessens his pleasure and it is up to the good projectionist to keep things running smoothly. He knows his theater, his equipment, the psychology of the public, and is on the alert to cope with any and all conditions which arise. He will not wait for trouble to manifest itself, but will see that the apparatus is kept in first-class condition.

The sound projectionist earns a weekly stipend of fifty to two hundred dollars, the exact figure being dependent upon ability and local conditions; but, to reach the higher financial rewards, we find that a high level of intelligence, including more than merely the mechanical, is required.

Duties of the Projectionist

In general, we may state that the machines must be cleaned, adjusted and tested every morning. In some installations storage cells are used for lighting the filaments of the amplifier tubes or for powering the exciter lamps, or possibly both; not merely one or two cells but whole batteries of

(Continued on page 407)

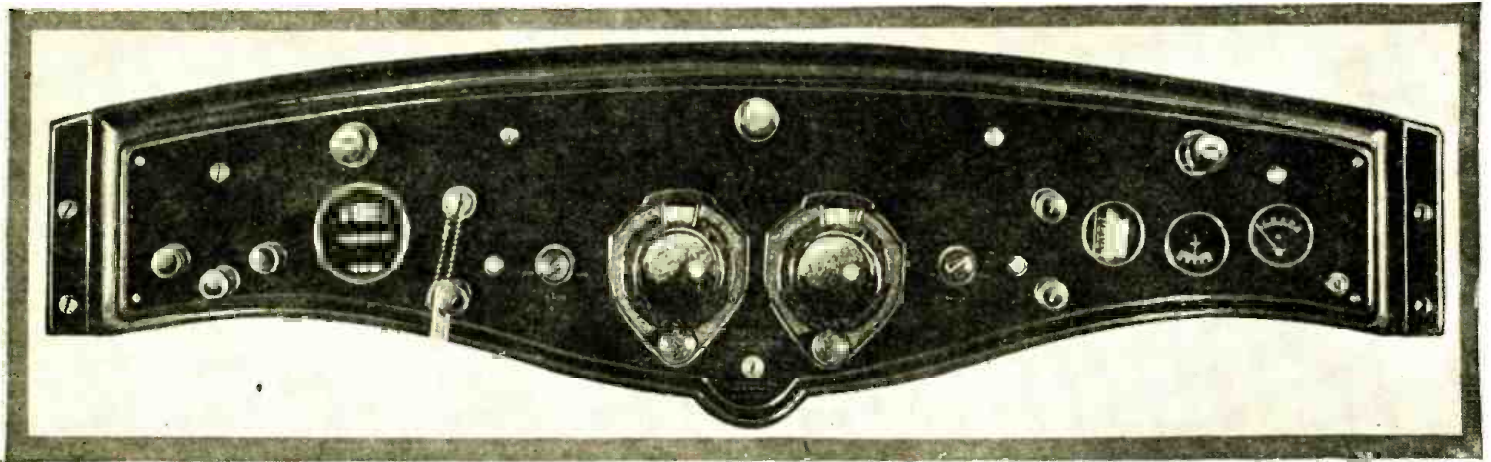

The radio-equipped automobile has a special instrument board, including the radio controls, which replaces the old panel.

Solving Automobile Radio Problems

How excellent reception can now be had in a moving motor car

By M. J. SHEEDY

NOW that the great American public is as much at home in the motor car as in the parlor, if not more so, the development of automobile radio as a commercial proposition is proceeding rapidly. While, hitherto, it has not been difficult to operate a portable radio from a car which had been parked, particularly where an aerial could be strung or a ground rod driven, the problem of operating a receiver from a car in motion was for years one for a most advanced experimenter. As in the case of airplane radio, it is complicated by the fact that an ignition system, capable of producing spark interference, is

necessarily located in the immediate vicinity. And the car operator, too, is handicapped by the fact that the compactness of his quarters does not permit him the long trailing aerial of a plane.

As stated editorially in the December issue of *RADIO-CRAFT*, the evident large market for receivers adapted to satisfactory operation from a moving car has stimulated commercial development. The illustrations accompanying this article show a model which has been designed especially for this purpose, and which is now available, with panel connections suitable for cars of all the standard makes.

The Stutz, Chrysler and Dodge makes of cars now carry this equipment as standard, and it is installed, optionally, on the Packard, Graham-Paige, Cadillac and LaSalle by the makers of the cars. Imported cars of European make are equipped at the plant of the Automobile Radio Corporation in New York City; and installations have been made at its branches throughout the country on cars of domestic manufacture.

The reproducer used in the installations is a magnetic cone, mounted above the windshield in closed cars, and under the instrument panel in open models. Limousine equipment necessitates two instruments, one front and one rear.

The "Transitone" System

The circuit, which is illustrated in Fig. 1, may at first glance seem disappointing in its simplicity; yet it represents the fruit of four years of engineering and experimental work. In fact, its simplicity is the keynote of its success (if the cliché may be utilized once more) under the trying conditions of operation which it must meet. The receiver has four tuned stages—three R.F. and a "non-regenerative" detector—with oscillation under control by the grid-suppressor method; followed by two stages of transformer-coupled audio amplification.

The tubes are of the battery-operated type, since the car affords an ample filament supply, ready at all times; "B" and "C" batteries are readily stored in the space beneath the front seats of the car. The '00A soft-detector is used, and a '12A power tube; the others are of the standard '01A type.

In order, however, that this set may operate with the greatest efficiency and the minimum of attention, an extraordinary degree of care is necessary to avoid undesired coupling effects. As illustrated in the views, the receiver, which is placed beneath the instrument panel of the car (slightly rearranged for the purpose) is completely shielded; its layout and wiring is a matter of great exactness, to prevent pick-ups, especially from the ignition system nearby.

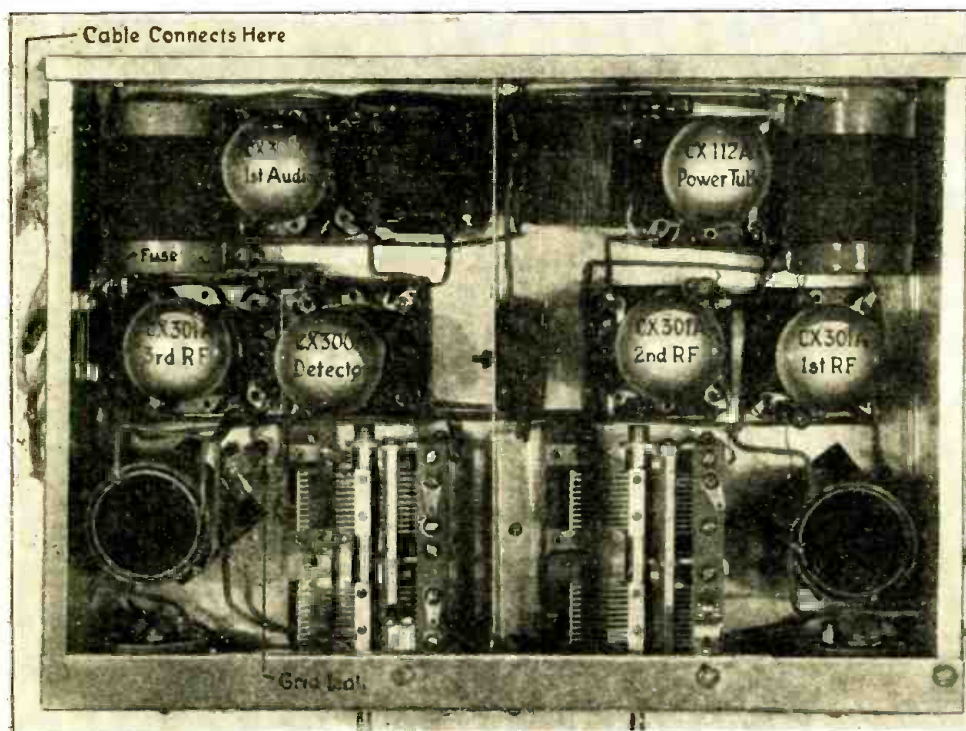

Internal appearance of the compact, completely-shielded chassis of a practical automobile radio receiver. It is mounted, in an inverted position, under the instrument board shown above; and all its leads are carefully protected against ignition interference.

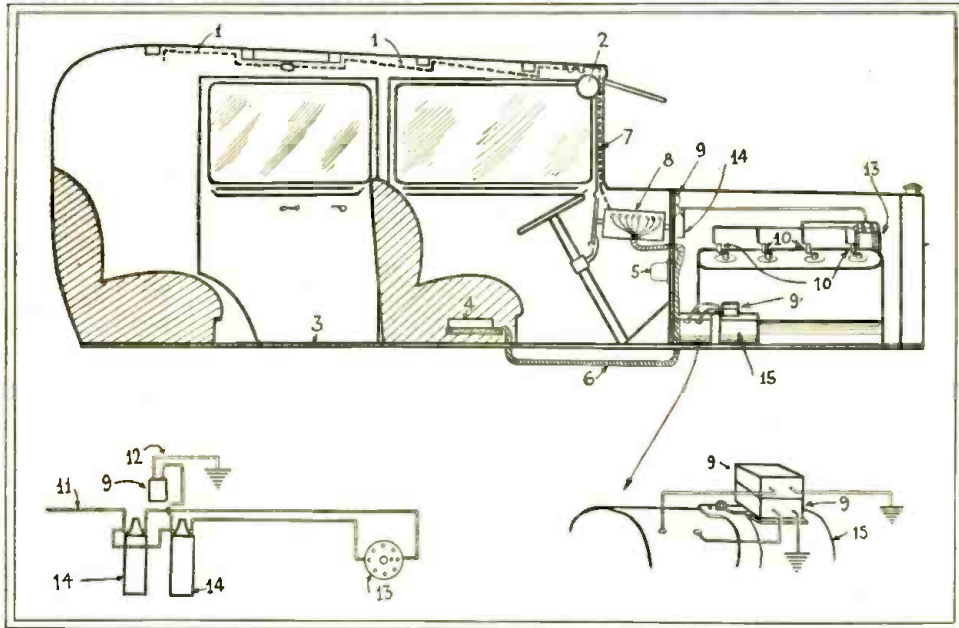

Fig. 2

The "Transitone" installation: 1, aerial; 2, reproducer; 3, car floor; 5, output filter; 7, aerial lead; 9, interference filter condensers; 12, "ground"; 13, distributor; 14, ignition coil; 15, generator. See illustrations below.

In addition to this, the ignition system is very thoroughly equipped with interference filters. These filters, or suppressors, have no effect upon the operating conditions of the motors; while their proper connection is essential to operation. In the Stutz laboratories, it was found that their connection did not effect a change in motor speed of one revolution per minute.

Double tuning control has been found desirable, as shown in the illustration; each knob controls two ganged condensers, and the dials will track very closely. The panel knobs are connected with the condenser shafts by flexible shafts. The volume is controlled by the R.F. filament rheostat. The set is turned on and off by the introduction of the master key.

Because the antenna system must be confined to the dimensions of the car, its size is limited. This problem has been met by constructing an aerial of wire netting in the top of the car (a folding top, in the case

of an open car, when reception is obtained with the top either up or down). The "ground," or more properly counterpoise,

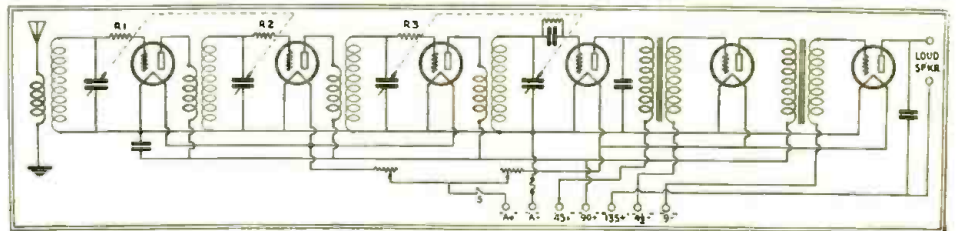

Fig. 1

The schematic circuit of the receiver illustrated below. The switch is S, the R.F. rheostat is a panel control for volume. The grid suppressors, R1-2-3, are 500, 3,000 and 100 ohms, respectively.

since it is insulated from the earth, is the frame of the car. However, the external connections depend upon the make of car; therefore, their polarity is not shown in the

to the breaker points, to the point where they pass through the engine partition.

(To be continued in March RADIO-CRAFT)

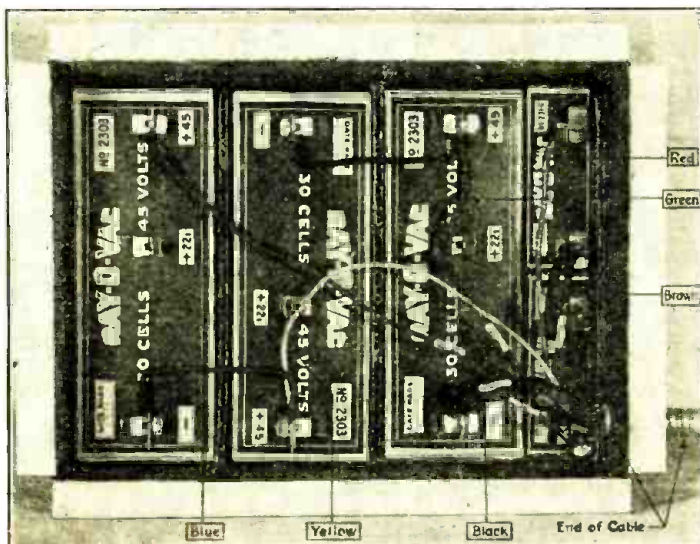

The carefully shielded "B" and "C" supply is pictured above. The battery leads are cabled through "BX" armored conduit; the color code being as indicated. These are 4 and 6 in Fig. 2, where the receiver is 8.

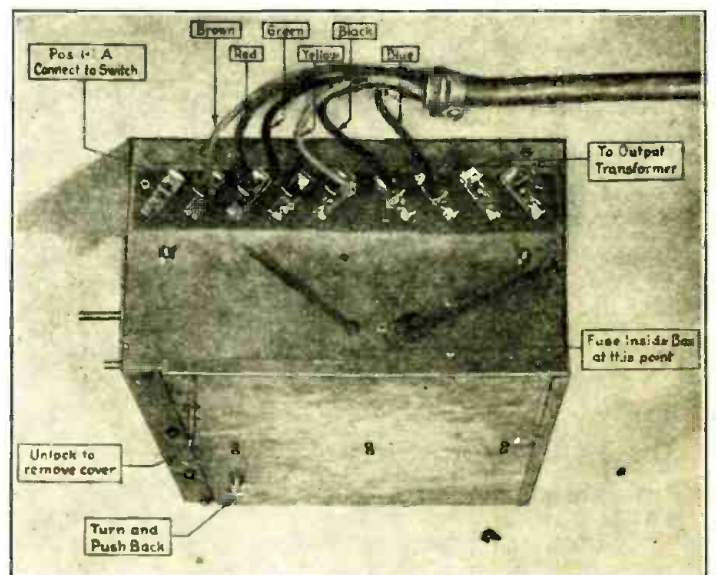

The unusual terminal-strip arrangement, necessary for an automobile receiver, is shown here; remember the tubes are mounted upside-down. The receiver is placed at 8 in Fig. 2.

The New Jenkins Radiovisor

Television instruments for the home present astonishing improvements, with the aid of the scanning system shown here and the receiver which will be described later

By D. E. REPLOGLE

TELEVISION, radio television, or radiovision for short, is in its formative state. It is an experiment about to become an industry.

Meanwhile, the commercial radiovision apparatus is about to be introduced. It will be in relatively simple and foolproof form, although necessarily high in cost at the beginning, because of a limited production. The Jenkins organization, in order to meet the requirements of the layman who is interested solely in the radiovision programs and not in the technique—the end rather than the means—is about to introduce a complete radiovisor in a handsome cabinet; a simple kit, for those who want to start out with a device that works, but is capable of changes and alterations; and a short-wave receiver especially designed for radiovision work.

Earlier Radiovisors

The earlier form of radiovision reproducing unit designed by C. Francis Jenkins comprised a wooden cabinet, containing a horizontally-mounted scanning drum which had a four-plate neon glow-lamp in its center, a synchronous motor and a commutator switch; and an inclined mirror, with large magnifying glass, mounted on its top.

The drum itself was pierced by forty-eight openings, arranged in four spiral turns of twelve holes each. Quartz rods from these openings extended along the radius of the drum from these points and terminated at the inner side of the hub; so that each was opposite the corresponding target of the glow-lamp during a time of rotation equivalent to the passage of its outer end over an angle corresponding to the picture width. This is clearly shown in Fig. 5. In Fig. 6,

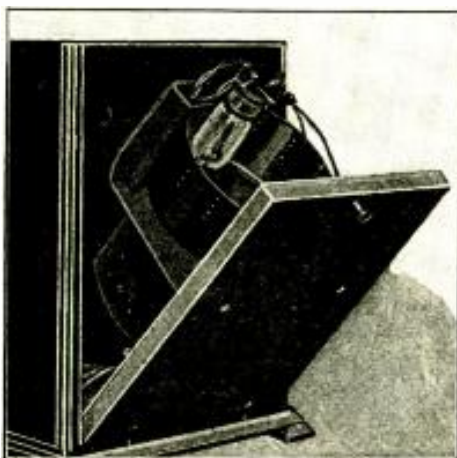

Fig. B

The rear of the new radiovisor opened, to show the simple lamp-and-drum arrangement now used.

the path of a beam of light from the glowing end of a quartz rod to the mirror, and from thence to the magnifying glass, is illustrated.

The lamp in the center of the scanning drum has its plates so wired to a distributor, or "commutator," that the first, second, third and fourth quarters of the scanning drum are illuminated, one at a time; each being flashed on in succession, at every fourth turn of the drum.

Each "target" or plate of the light-source is to serve only during one turn, and the

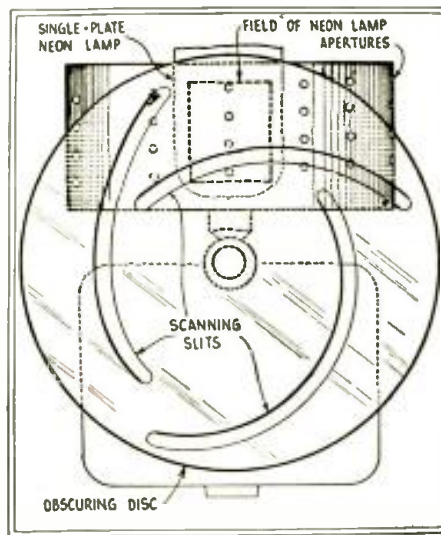

Fig. 7

The mechanism of the new Jenkins visual reproducer, shown from the rear in Figs. B and C.

picture-current input to the device is "commutated" by a rotary switch geared in the proper ratio to the drum-rotating shaft.

The distance traveled by the inner or lamp end of the quartz rods is much less than that traveled along the outer circumference and the "targets" need be but a fraction of an inch square; since the rods are sloped inward to the target.

The property of the quartz rods utilized in this method is that the light admitted at one end is transmitted undiminished through the length of the rod to its outer end, like the flow of water through a pipe.

The four turns, illuminated in rotation, serve to make up a view or "field" equivalent to that obtainable from a disc-scanning device some thirty-six inches in diameter.

The New Model

Because of production demands, and the expense of the quartz rods, this model was torn down to its basic principles, and an entirely new design worked out.

At first, the same form of scanning drum,



Fig. A

The radiovisor in its plain cabinet; the image is formed at the end of the "shadow box."

with light-conducting rods and a four-plate neon lamp, was retained; but the optical system was changed to view the scanning drum through the magnifying lens direct, without the mirror to reflect the beams. This simplified the cabinet; since everything was then placed inside, with the magnifying lens recessed in an opening in front, to form a "shadow box." Further development, however, has resulted in a much simpler mechanism; comprising a plain scanning drum, a single-plate neon lamp, and an ingenious selector shutter. This not only reduces the cost to a very marked degree, producing a quieter mechanism, but actually secures far better detail in the pictures.

The cabinet measures approximately 18 by 18 by 24 inches. The front end contains the shadow box; through which the radio movies are viewed in considerable enlargement, due to the concealed magnifying lens. Below the shadow-box opening is a control panel with "framing crank," and toggle switches controlling the loud-speaker and picture functions, as well as the starting, accelerating and stopping of the motor.

The first switch snaps on the neon glow-lamp. The short-wave radio set, employed in conjunction with the televisior, is tuned in the usual manner, until the characteristic buzz-saw note of the television signal is at maximum in the loud speaker. The second switch serves to turn off the loud speaker, so that the visual interpretation may now be obtained. The third switch turns on the motor and also serves as a simple method of bringing the scanning drum into step with

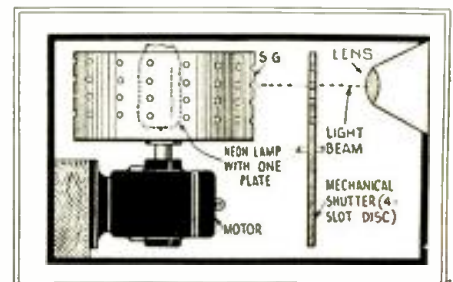

Fig. 8

A schematic diagram of how the image is thrown directly into the "shadow box" of the new model.

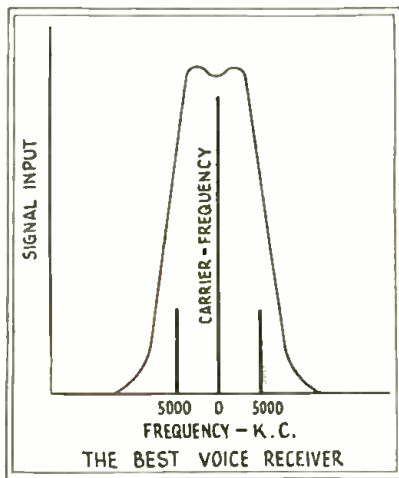

Fig. 2

The characteristic curve of a high-quality radio receiver, with very good R.F. and A.F. channels.

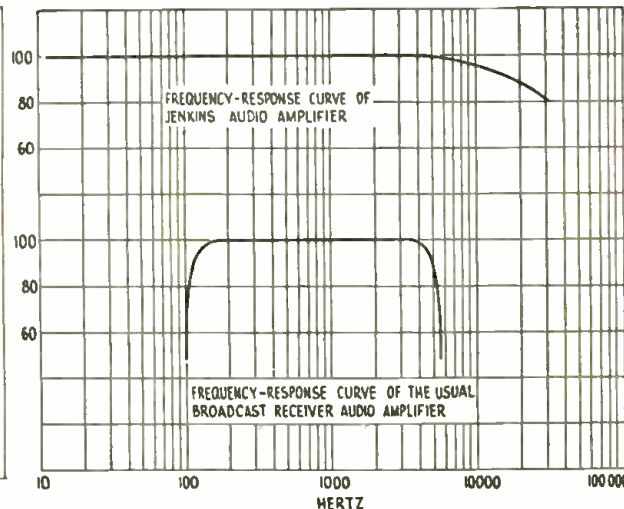

Fig. 1

The efficiency of the new Jenkins' amplifier for television, compared on a logarithmic scale with that of a receiver good enough for all audible reception.

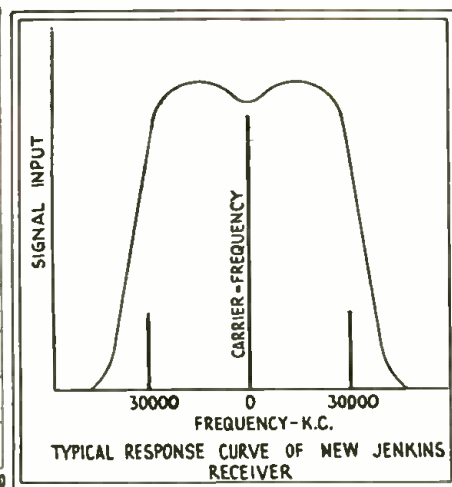

Fig. 3

Satisfactory reception of television requires an amplification curve like that shown above.

the picture. The crank is turned to frame the picture properly from left to right.

The scanning-drum holes, when viewed through the magnifying lens, give an apparent screen size about 6 inches square; sufficient for the simultaneous entertainment of six to eight persons.

The combination is no longer obtained electrically but by means of a mechanical substitute called an "obscuring disc," which reveals to the eye only the hole then traversing the field of the light source (in this case a neon-tube having a discharge surface slightly larger than the image to be secured.) This is illustrated in Fig. 7. The relation of the obscuring disc to the drum and magnifying lens is shown in Fig. 8. The neon-tube is placed directly behind the wall of the drum; with its plate exactly in line with the shaft of the motor and the drive-shaft of the obscuring disc. The positions of the scanner and single-plate neon tube are pictured in Fig. B.

In Fig. C the motor, drum scanner, and obscuring disc are shown, with the neon-lamp in position.

It goes without saying that the selected signal must be matched to the particular radiovision apparatus available. In other words, a 48-line picture signal must be tuned in for a 48-line scanning mechanism.

Which brings us to a consideration of the apparatus required to receive radiovision signals properly. Television broadcasting, being now carried on in the frequency band between 2,000 and 3,000 kilocycles, cannot be handled with the usual broadcast receiver. A short-wave receiver, covering the wavelength range of 100 to 150 meters, at least, is essential to tune in radiovision signals.

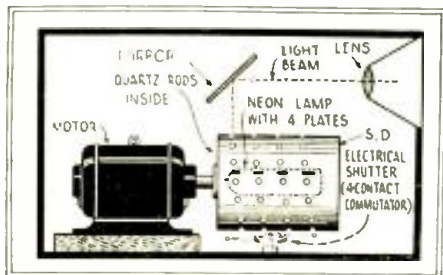

Fig. 6

A reflecting system, indicated here schematically, was needed with the older quartz-rod drum.

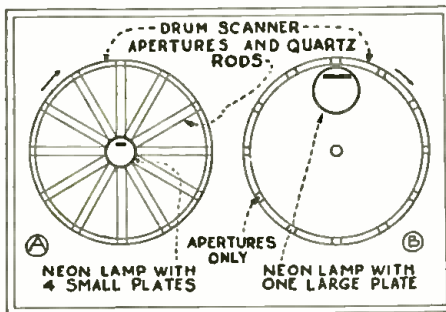

Fig. 4

Left, the old system; right, the new.

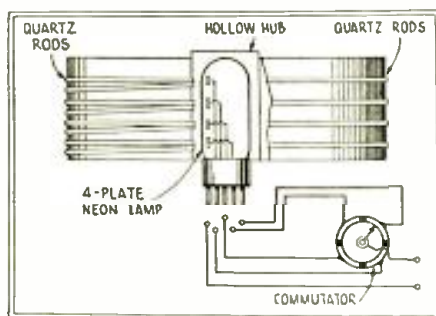

Fig. 5

The ingenious but expensive mechanism of the earlier Jenkins radiovisor.

Amplifier Faults

The usual short-wave receiver today comprises a stage of screen-grid radio-frequency amplification, a regenerative detector, and one or two stages of transformer-coupled audio stages. While such an arrangement may be satisfactory for sound signals, it falls far short of meeting good radiovision requirements. To begin with, the radio-frequency end is usually too selective and, therefore, cuts off the wide side-bands so essential to good pictorial detail.

Then the "regenerative" feature, if pushed to any considerable degree, tends to sharpen the tuning, resulting in a further elimination of sidebands. If the detector circuit is permitted to oscillate, marked distortion is introduced in the picture.

Finally, the audio end, in even the best short-wave receivers with good audio transformers, will begin to cut off at 3,000 cycles; which, while not noticeable in sound reproduction, is fatal to pictorial reproduction.

In radiovision, we do not get much of a picture unless we can amplify frequencies up to 10,000; and 30,000 cycles is the present goal.

What does "frequency cutoff" mean in pictorial terms? If the audio amplifier cuts off at, say, 5,000 cycles, which is the result with a good circuit, it is possible to obtain a fair outline of figures of a silhouette effect, without half-tone values and fine detail. Plain black-and-white pictures, such as the Jenkins "radionovies", reproduce well with the better types of short-wave receivers and audio amplifiers now in use; which accounts for the broadcasting of these simple silhouette pictures during the experimental period of radiovision.

When it comes to half-tones, however, an audio amplifier capable of handling frequencies up to 10,000 cycles at least, is essential for "detail" and half-tone values in the form of finer shades.

Regeneration is a troublesome and even detrimental feature. There is no harm in having regeneration available, for the sole purpose of locating signals by means of an oscillating detector. Once the signal is located, regeneration should be reduced to (Continued on page 409)

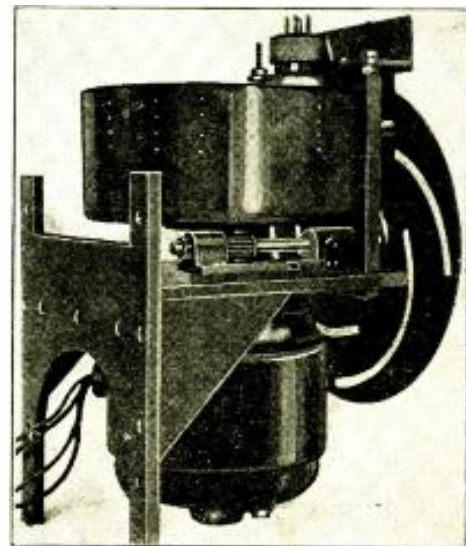

Fig. C

The works of the new radiovisor; the slotted disc in front obscures all but one hole, to prevent the formation of multiple images.

The Cathode-Ray Television Receiver

Results Obtained with New Vacuum-Tube Visual Reproducer Justify Twenty-Year-Old Theory for Reception without Machinery

EXPERIMENTS in television with a new type of receiver, from which the cumbersome scanning disc has been eliminated, were recently described before a district convention of the I. R. E. by Dr. Vladimir Zworykin, famous tube expert, who has been testing the utility of the cathode-ray tube for this purpose, in the East Pittsburgh laboratories of the Westinghouse Electric and Mfg. Co.

The theoretical value of the cathode-ray tube, with its weightless beam of light, moving without mechanical parts, has been evident for many years to those who have considered the problem of television. It was proposed as long ago as 1907 by Boris Rosing, a Russian physicist. However, as with Nipkow, the inventor of the scanning disc, Prof. Rosing was ahead of his time.

Primarily, the cathode-ray tube is a device in which electrons emitted from the cathode (which corresponds to the filament of the earlier, and simpler, radio tubes) are drawn away from it by a high voltage on the other electrode, or anode. The higher the voltage, the greater the speed of the ray. The cathode ray itself (as with the X-ray, which is only one form of cathode ray) is invisible. It may, however, be made visible by contact with *fluorescent* material, which it causes to give off visible light.

The Oscillograph

The beam of cathode rays is composed of moving electrical particles; it is therefore capable of being attracted from side to side in an electrical or magnetic field. In the well-known device of the oscillograph, the beam is subjected to the influence of two varying magnetic fields at right angles to

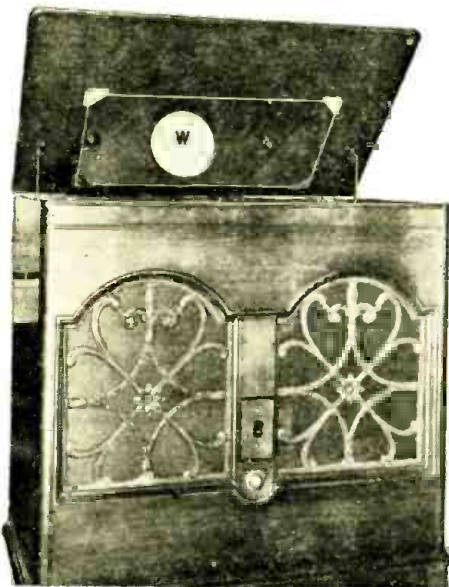

Fig. B

The mirror in the console lid reflects the image on the target of a "kinescope" set below it.

each other; and it is thereby caused to describe curved lines of light on its luminous screen. This same action furnishes the scanning motion required by Dr. Zworykin

Fig. A

At the right, Dr. Zworykin is shown holding his new tube, the "kinescope," on the large or target end of which moving images are built up by a ray of moving electrons. Its essential parts are shown below in cross-section in Fig. 2, and the cathode filament on a larger scale in Fig. 3.

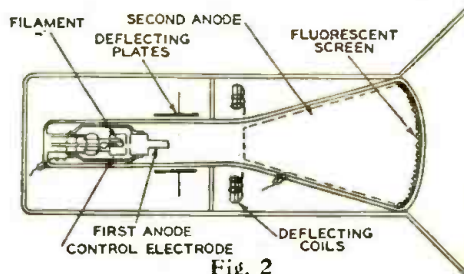

Fig. 2

ELECTRON GUN

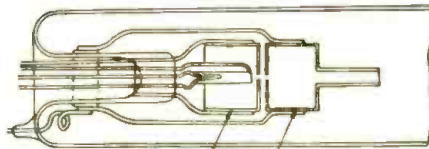

Fig. 3

Details of the cathode-ray projector.

in his television receiver; while the variations of the intensity of the ray—with the voltage on its controlling element—affect the brilliancy of the light on its screen, and produce the bright and dark contrasts necessary in a television image.

While the apparatus illustrated here is still in the stages of development—with the end in mind of creating a home television receiver which is quiet in operation and has no moving parts to require care from its operator—its inventor states that he is "already in position to discuss the practical possibility of flashing the images on a motion-picture screen, so that large audiences can receive television broadcasts of important events, immediately after a film of these is printed. These visual broadcasts would be synchronized with sound."

The tube, shown in Dr. Zworykin's hand in Fig. A, reproduces its moving images on the larger, or "target," end which is covered with a material known as Willemite (a zinc ore) or a similar fluorescent substance. This end of the tube is about seven inches in diameter, and it is possible to throw on this an image as large as 4 x 5 inches. However, a serious problem attending its operation is that of the voltage necessary. The tube should operate with at least 3,000 volts of

anode (corresponding to plate) potential; and more if images larger than 3 inches square are required. The picture thus formed is green, instead of red, as with a neon glow-lamp; the new tube requires, however, less power output from the amplifier of the radio receiver to produce brilliant images.

A Proposed Design

The arrangement shown in Fig. B, for a home television receiver, shows the tube built, in a vertical position, into the console of a set of commercial design. A mirror set in the lid of the console, when turned up to an angle of slightly more than 45 degrees, makes the image visible to a large number of spectators, even in a moderately-lighted room. The automatic scanning system holds the image in frame; since the impulse of the ray upon its fluorescent target has a persistence comparable to that of the human eye, the image lingers slightly, and it is possible to reduce the number of "frames" needed per second. This, again, makes it possible to transmit more scanning lines on a single radio channel, and give larger images in more detail.

As with other experiments in television at these laboratories, images have been broadcast through the transmitters of KDKA; being taken from reels of moving-picture film to assure standard modulation. The film is run through a projector, resembling in many ways those of the "talkies," but all the images it contains are converted into electric impulses by means of a photoelectric cell. The output of this, after tremendous amplification, is used to modulate the carrier wave of the transmitters. The scanning of the image on the film, at the transmitting end, is accomplished by projecting through it a very minute ray of concentrated light, reflected from a vibrating mirror which is driven, in a magnetic field, by an alternating ("sinusoidal") voltage impressed upon the coils to which it is fastened. The result of this is that the mirror moves most rapidly in the center of the image. It was therefore necessary to exclude a portion of the mirror's swing from the scanning transmission; but the light-ray is effective 85% of the time.

The circuit used in the reception of television signals and their reproduction in visible form by Dr. Zworykin's tube: the signal is sent as a double modulation; part of which represents the image; and part the "framing" frequency, which synchronizes the movements of the cathode ray with those of the scanning beam at the transmitter.

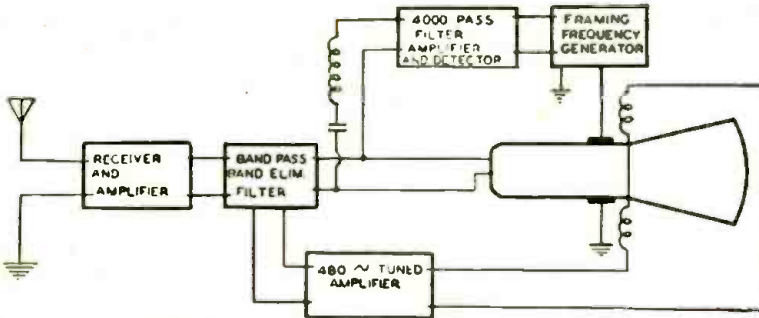

Fig. 1

The "Cathode Ray"

At the receiver the signal is detected and amplified in the usual manner, led to the band-pass filter (Fig. 1) and then to a "controlling element" regulating emission from filament of the cathode tube, just as the grid controls the current passed by an ordinary vacuum tube. (See detail of the "electron gun" in Fig. 3.) Through the narrow opening in this control element, a stream of electrons darts into the first anode A, and then out, past the deflecting plates. The first anode, with a potential of 300 to 400 volts, gives the electron stream a certain velocity; this, when the stream passes through the opening in the first anode, is further highly increased by a potential of 3,000 to 4,000 volts impressed on the metallic coating of the inner walls of the bulb.

With no deflecting influence from either side, the electron stream would continue straight down the center of the tube—as shown in an interesting photograph made from an oscillograph tube operating on similar principles (Fig. C). However, in the neck of the new Zworykin tube there are two sets of deflecting devices; the first, working electrostatically, swings the ray back and forth, to correspond with one motion of the scanning transmitter. The second detector, having coils, sets up a magnetic field and moves the beam at right angles to the first deflection. The result is a complete scanning of the fluorescent screen on the target. At the same time, the modulation of the biasing voltage (on the controlling element or grid, next to the filament) varies the intensity of the ray, and consequently the brilliancy of the moving spot of light. The result is that an image of light and dark points is built up, in synchronism with the transmission; just as

in the system of mechanical scanning in front of a glow-lamp.

In order, however, to accomplish this purpose, it was necessary to design a special tube; the device Dr. Zworykin has produced for television, he calls the "Kinescope." In laboratory cathode-ray tubes, a high degree of vacuum has been maintained only by connecting them to an air pump in constant operation; this is impossible for home apparatus. The previous low-voltage tubes have not given enough light for the duty imposed in this case. The kinescope has an oxide-coated, indirectly-heated cathode, and its various operations are under thorough control through the means described above.

Synchronizing Methods

For the radio transmission of television signals in a single "channel," there is superimposed upon the image-frequency (from the photoelectric cell) a series of high audio-frequency impulses, occurring only when the light beam passes the interval between pictures, and lasting but a few cycles. A band-pass filter removes the picture component, which is of the same frequency as that of the horizontal scanning. Then a portion of the voltage which drives the vibrator, at the transmitter, is impressed upon the signal, and the complex current thus produced is passed into the modulator and registered on the carrier wave.

At the receiver, the band-pass filter (Fig. 1) separates the synchronizing frequency from the signal; the latter goes to the control element, and the former to the deflecting coils of the kinescope. The modulation caused by the framing impulses does not affect the pictures, because it occurs only in the intervals between frames.

In the operation of the kinescope, the deflecting plates are connected in parallel with a condenser which is charged by a constant

current supply from a current-regulating (two-element) tube. As the condenser charges, the attraction of the deflecting plates moves the ray from the bottom to the top of the fluorescent target at increasing speed. The impulses sent out from the transmitter, between pictures, cause the condenser to be discharged, automatically returning the beam to the bottom position, where it is ready to scan another frame.

With a receiver of this kind, no more signal on the grid ("controlling element") is required than for an ordinary vacuum tube; no motors for driving or synchronizing are introduced; and the technical advance represented over previous television methods is considerable. Further developments, from an experimental and a commercial viewpoint, will be eagerly awaited.

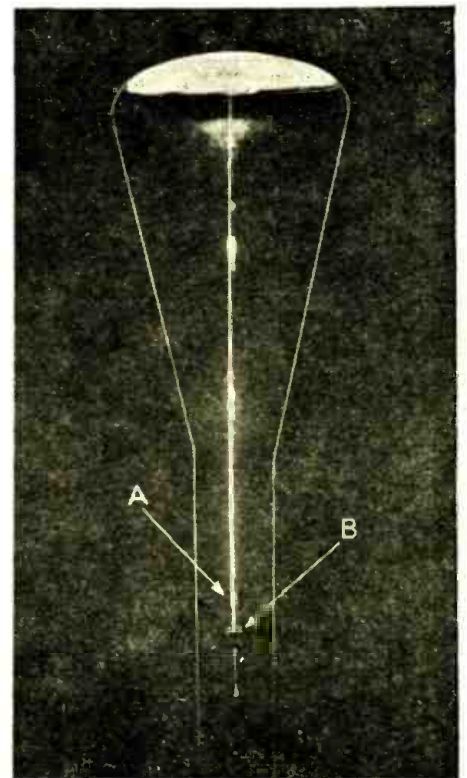

Fig. C

This extraordinary photograph of a cathode-ray oscillograph shows the action of a device very similar to Dr. Zworykin's. The electron stream is governed, in its motions from side to side, by the magnet coils A and B.

(Photograph by Baron Manfred von Ardenne, Berlin, Germany.)

Airplane Radio Creates Many Jobs

THERE is no chance for anyone in radio any more! All the good jobs have been gobbled up. Radio has settled down to a cut-and-dried business of selling complete radio sets, that you put into use merely by plugging their connections into lamp sockets. Set selling and servicing—that is all there is to radio."

How often has this been said? Far too many times; and the reason is that thousands of really good technicians have not realized the tremendous strides which have been made by moneyed interests operating outside the regular broadcast bounds—and without brass bands. The recent growth of aviation radio has been astonishing.

We note a recent announcement by

officials of the Boeing Air Transport division of the United Aircraft and Transport Corporation; wherein we see direct evidence of the need for technical radio men who may come to be known as "radio pilots"; "beacon installers"; "beacon-maintenance engineers"; "beacon control-tone checkers"; "frequency-checking-station engineers"; "ground radio-tricians"; "radio block-system supervisors"; "de luxe express-passenger-service radio operators"; "radio-line switchboard operators" (for monitoring, and switching to a regular telephone line, conversations to and from aeroplanes); "airplane radio-equipment designers"; "plane radio-equipment inspectors"; "plane radio-installation supervisors, and installers."

Airplane Radio Service

That such positions have become present-day actualities rather than possibilities of the future, is proved by the Boeing and other announcements of a highly-developed system of radio communication, for use in air transport, which will enable pilots to keep in touch with the ground and each other in flight.

Under one system hook-up, which will extend over the lines of the Boeing section of the transcontinental air-mail route from Chicago to the Pacific, a regular block system by radio will be the method by which traffic along the line will be regulated. Pilots will be able to talk with each other in flight;

(Continued on page 412)

SHORT WAVE CRAFT

A "Composite" Short-Wave Receiver

By ROBERT NEIL AUBLE

THE short-wave receiver to be described in the following article was designed primarily for that class of radio enthusiast who, by reason of limitations in the family budget, must "roll his own." In these days of push-pull power packs, super-dynamics, etc., the cost of home experiment for the fan who likes to keep apace with developments in radio, is becoming excessive; and many of us must perforce choose between beefsteak for dinner, on the one hand, and possibly a short-wave receiver on the other. But, even after choosing the receiver, the budget allowance must necessarily be spread out pretty thin.

And having decided that it must be cheap, there is again the choice between a receiver cheap merely in price as against one cheap in performance also. This new receiver is cheap in price, but its performance is up to par with that of the best of factory-assembled kits.

The circuit of the receiver is a composite one: the antenna circuit was borrowed from an advertisement; the tuning circuit was stolen bodily from a magazine article; and the audio amplifier is so standardized that its origin is lost in antiquity. But the layout is the writer's own; and it is his experience that the whole secret of success with short waves lies in that feature of the receiver.

The truth of this statement is more apparent when it is remembered that the tuning coil has only three to twelve turns of wire, and that the tuning condenser has capacities measured in terms of micro-microfarads. The introduction of additional inductances or capacities by means of the lead wires must be avoided; because a short-wave receiver wired without regard to this all-important detail will not receive, no matter how beautiful the cabinet.

Design of the Receiver

The circuit includes an untuned stage of radio-frequency amplification (using a screen-grid tube), a regenerative detector, and two stages of transformer-coupled audio amplification (see Fig. 1). A metal panel, preferably brass or aluminum, is used, and the sub-panel is also metal. If heavy-gauge yellow brass is given a high polish and finished with a coating of transparent lacquer, a very attractive receiver results. The screen-grid tube is shielded by means of a brass cup. Shielding other than that afforded by the metal panel is not necessary for the successful operation of the receiver.

If it is desired, however, to shield the detector tube and its input circuit the position of the shield is indicated by the dotted lines in the layout diagram (Fig. 2). If such shielding is used, care must be taken

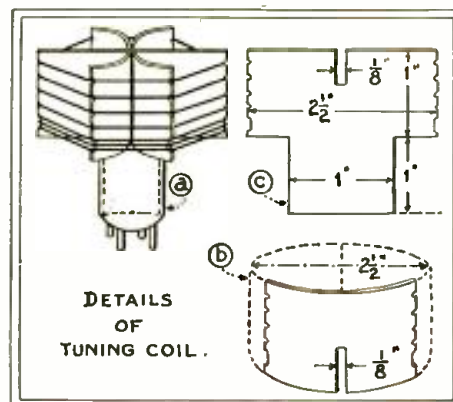

Fig. 3

Mr. Auble's home-made coils, of which the smallest is shown here, are wound on a form "turned inside out" to give low losses, as described elsewhere.

to keep the lead wires properly spaced from the shielding material; since the wires passing through the shield, except the filament leads, are carrying high-frequency currents which are difficult to control and isolate if stray capacities are present.

From Fig. 2 it will be noted that all units operating at radio frequency are located at the front of the sub-panel, in such fashion that the leads are short and widely spaced from each other. It will be observed also that the units operating at audio frequencies are located at the back of the sub-panel and very widely separated from the high-frequency units. The condenser used for controlling regeneration is placed near the rear of the receiver and operated by means of the long shaft. This position was selected for this condenser because it prevents feedback currents getting back into tuned circuits at any point except in the tuning inductance itself; the position chosen also avoids hand capacities in tuning since, not only is the shaft grounded, but the high-potential plates are at a considerable distance from the front panel, which is also grounded. The battery wires are cabled together and brought into the receiver in such a position that they do not introduce stray capacity. High-frequency currents are likewise isolated and confined by means of the choke coils and by-pass condensers.

In connecting the various units to ground at the several points indicated care should be taken that the connection is electrically perfect. It is suggested, as an additional precaution, that all grounded points be connected together by means of a wire on the lower side of the sub-panel. This will provide a common low-resistance path for grounded currents, and avoid troublesome

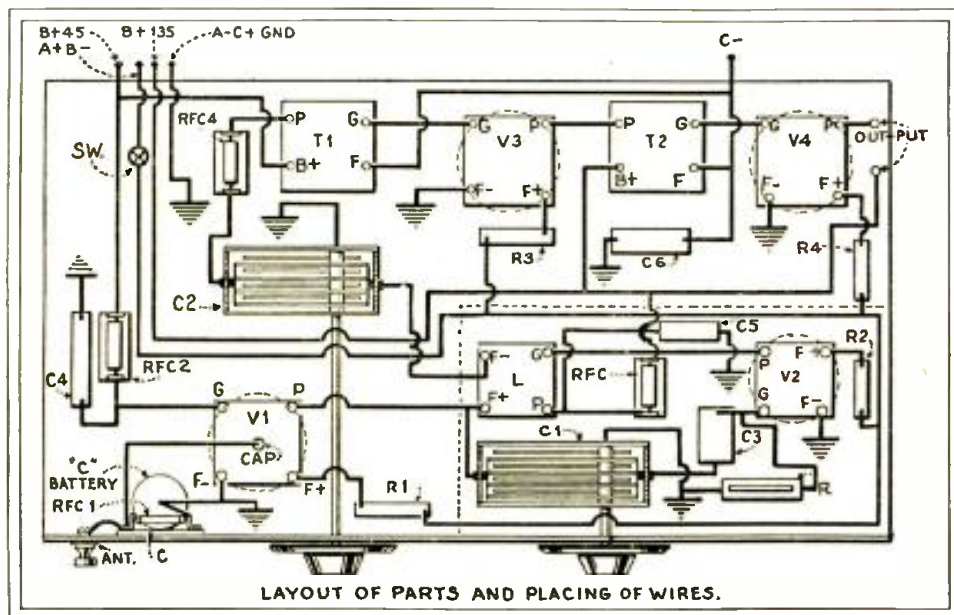

Fig. 2

The layout used by the writer is shown here, except for a negative grid-leak return, which is often advantageous in short-wave oscillating detector circuits. A positive return may be used, if preferred.

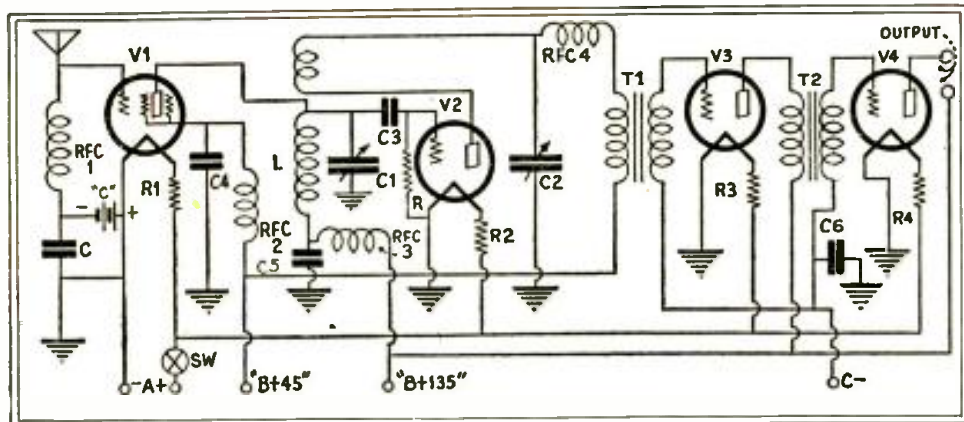

Fig. 1

The circuit shown is not unusual; efficiency with a properly-constructed, well-shielded screen-grid receiver is high, and operation will present no special difficulties. Tube V1 must be, and V2 may be, shielded.

effects from eddy current in the sub-panel itself.

The filament temperatures are controlled by means of fixed resistors. There remains but two variable elements to be used in tuning. The regeneration control will be found very broad, so that stations may be located by the single tuning condenser.

The Special Chokes

Four radio-frequency chokes should be used. While factory-wound chokes may be used, it is preferable to use home-made components; since the characteristics of the several chokes may be studied and the best one chosen at little expense. To make them, cut four sections of rubber rod 1/2-inch in diameter and one inch long. In each section cut, with a very thin-bladed coping saw, two (Continued on page 411)

The Hammarlund Short-Wave Adapter-Receiver

By LEWIS WINNER

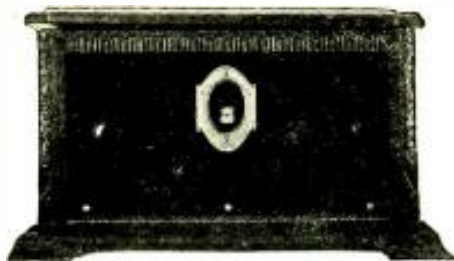

The adapter-receiver described in a small neat cabinet presents an appearance worthy of parlor use with a standard high-grade broadcast receiver.

THE adapter-receiver illustrated and described here contains a screen-grid tube ('22 type) in an efficient stage of R. F. amplification, ahead of a super-sensitive regenerative detector. Connected to the audio amplifier of a broadcast receiver, it produces a short-wave set that is stable as well as excellent on distance, and giving loud speaker volume on foreign stations.

The antenna circuit is controlled in the simplest manner—by a variable resistor in series between the aerial and the ground. (The best results are obtained from an aerial twenty to sixty feet long, and as high as possible.) The selectivity is maintained by coupling the first R. F. tube (the '22) to the detector by a condenser and a tuned impedance; acknowledgedly, the most effective method. The condenser (C2 in the diagram) is of 20 to 100-mmf. capacity range, and its adjustment is not critical. It is of the screw-control type, having phosphor-bronze plates, with mica insulation, whose spacing is regulated by the screw.

Coils Used

To tune the grid circuit of the detector, as well as the plate of the screen-grid tube, a .00014-mf. variable condenser, C, is used. This capacity allows easy tuning from 15 to 215 meters with the plug-in coils used.

On short waves there is nothing so important, so vital to successful operation as the use of low-resistance coils, with low distributed capacity.

Since dielectric losses increase very rapidly with the frequency, the absolute minimum must be obtained. This requirement is maintained in these coils by space-winding the turns (which must be done evenly to secure uniform current distribution) over a celluloid-like form 1/200-inch thick, with silk-over-cotton wire. The coil is wound ten turns to the inch; so that the spacing between successive turns is slightly more than the diameter of the wire itself.

In the standard mounting base used, provision for a variable coil (primary or tickler, as preferred) is made for the benefit of the experimenter. It is not required in this circuit, when only the short waves are to be received. This coil (which would be L1 if used) has regularly six turns, wound to a diameter of 1-13/16 inches with No. 18 wire.

For the coils designed to cover the bands with the .00014-mf. condenser used, the following are the manufacturer's specifications. (A constructor would have to dup-

licate exactly the spacing, etc., a work of much difficulty, in order to obtain the same tuning range with home-made equipment.) The 120-meter coils are wound to 3-inch diameter, and the shorter-wave coils to a 2-inch tube.

Waveband (meters)	Wire Gauge	Turns L2	Turns L3
20	16	4	3
40	16	10	5
80	16	21	9
120	18	32	15

The Detector

In the detector circuit the parallel-feed system is used; this permits the smooth oscillation control so necessary in the short-wave bands. With this method, oscillations do not come in with a "hang-on" or "drag", when the regeneration condenser is reduced sufficiently to stop oscillation. Instead, there is that steady, velvety increase of feed-back (Continued on page 406)

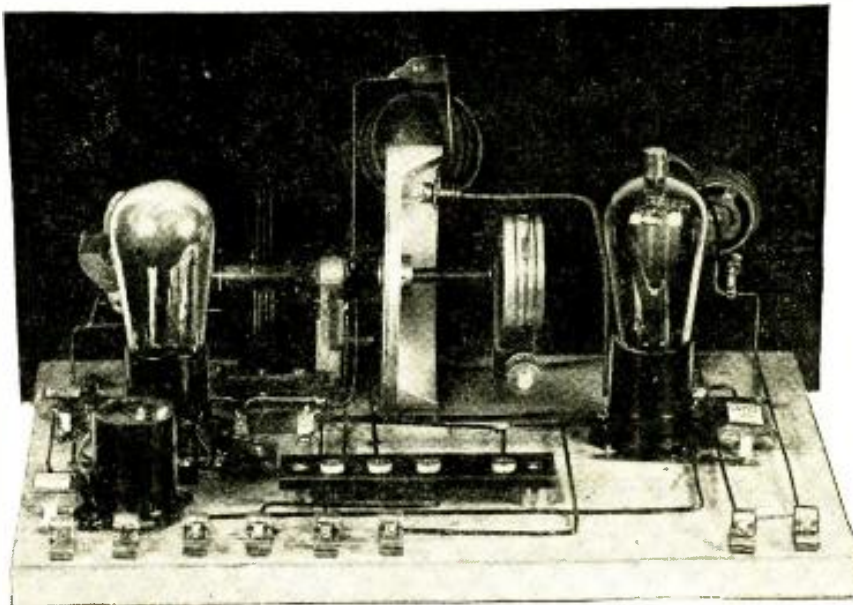

The simplicity of the adapter-receiver may be seen at once from this view of the chassis; the layout is obvious. Right-angle crossing of high-potential leads lessens undesired coupling.

Short-Wave Stations of the World

All Schedules Eastern Standard Time: Add 5 Hours for Greenwich Mean Time.

Kilo-Meters	Cycles	Station	Notes
14.50	20,680	Monte Grande, Argentina	after 10:30 p. m. Telephony with Europe.
14.84	20,200	DGW, Nauen, Germany	2 to 9 p. m. Telephony to Buenos Aires.
15.03	19,950	LSG, Monte Grande, Argentina	From 9 a. m. to 1 p. m. Telephony to Paris and Nauen (Berlin).
		DH, Nauen, Germany	
15.50	19,350	Nancy, France	4 to 5 p. m.
		FW3, Paris, France	From 10 a. m. Telephony to Monte Grande (Buenos Aires).
		VK2ME, Sydney, Australia	
15.85	18,920	XDA, Mexico City, Mex.	12:30 to 2:30 p. m.
15.94	18,810	PLE, Bandoeng, Java	Broadcasts Wed. 8:10 to 10:40 a. m. Telephony with Kootwijk (Amsterdam).
16.10	18,620	GBJ, Iodmfin, England	Telephony with Montreal.
16.10	18,620	PCK, Kootwijk, Holland	Daily from 1 to 6:30 a. m.
16.11	18,610	GBU, Rugby, England	
16.35	18,350	WND, Deal Beach, N. J.	Transatlantic telephony.
16.38	18,310	GBS, Rugby, England	Telephony with New York. General Postoffice, London.
16.50	18,170	CGA, Drummondville, Quebec, Canada	Telephony to England. Canadian Marconi Co.
16.54	18,130	GBW, Rugby, England	
16.57	18,120	GBK, Rugby, England	
16.61	18,050	KQJ, Hollnas, Calif.	
16.80	17,850	PLF, Bandoeng, Java	"Radio Malabar". Works with Holland.
16.88	17,770	PHI, Huitzen, Holland	Beary station to Dutch colonies. Broadcasts Mon., Wed., Thurs., Fri. 8 to 11 a. m. N. V. Philips Radio, Amsterdam.
16.90	17,740	HSIPJ, Bangkok, Siam	Broadcasts 9 to 11:30 a. m.
17.20	17,440	Nauen, Germany	
17.34	17,300	W2XK, Schenectady, N. Y.	Tues., Thurs., Sat. 12 to 5 p. m. General Electric Co.
18.40	16,300	PCL, Kootwijk, Holland	Works with Bandoeng from 7 a. m. Netherland State Telegraphs.
18.56	16,150	GBX, Rugby, England	
18.75	15,990	Saigon, Indo-China	
18.80	15,950	PLG, Bandoeng, Java	Afternoons.
19.56	15,340	W2XAD, Schenectady, N. Y.	Broadcasts Sun. 2:30 to 5:40 p. m., Tues., Thurs. and Sat. noon to 5 p. m., Fri. 2 to 3 p. m.; besides relaying WGY's evening program on Mon., Wed., Fri. and Sat. evenings. General Electric Company.
19.60	15,300	Lyngby, Denmark	Experimental.
20.00	14,990	TFZSH, Iceland	
20.50	14,625	W8XF, Pittsburgh, Penna.	
20.80	14,420	VPD, Suva, Fiji Islands	
22.20	13,500	Vienna, Austria	
22.38	13,400	WND, Deal Beach, N. J.	Transatlantic telephony.
22.69	13,050	W2XAA, Houlton, Me.	Transatlantic telephony.
23.35	12,850	W2XD, Schenectady, N. Y.	Antipodal program 9 p. m. Mon. to 3 a. m. Tues.; noon to 5 p. m. on Tues., Thurs. and Sat. General Electric Co.
		W6XN, Oakland, Calif.	Relays KGO from 8 p. m., Mon., Wed., Thurs. to 2:45 a. m. Tues., 3 a. m. Fri., 4 a. m. Sunday. General Electric Co.
24.41	12,280	GBU, Rugby, England	
24.50	12,240	FW, Ste. Assise (Paris) France	Works Buenos Aires, Indo-China and Java. On 9 a. m. to 1 p. m. and other hours.
		KIXR, Manila, P. I.	
		GBX, Rugby, England	
24.68	12,150	GBS, Rugby, England	Transatlantic phone to Deal, N. J. (New York).
25.10	11,940	Zeesen, Germany	Tests of new Super-power broadcasters.
25.40	11,800	W8XK, East Pittsburgh, Pa.	Relays KDKA after 6 p. m. Tues. and Thurs. from 5 to 7. Westinghouse Electric Co.
25.53	11,750	G5SW, Chelmsford, England	Relays 2LO London, 2 to 7 p. m. experimental transmission from 7 to 9 p. m. and 7:30 to 8:30 a. m. and tests with W2XO 12 to 1 p. m. Mon. and Thurs. Silent Sat. and Sun. British Broadcasting Co.
25.60	11,710	CJRX, Winnipeg, Canada	5:30 to 8 p. m. daily. Sun. 1 to 2 p. m. Relays CJRW. James Richardson & Sons, Ltd.
25.68	11,670	K10, Kahuku, Hawaii	
26.00	11,530	CGA, Drummondville, Canada	
26.10	11,490	GBK, Rugby, England	
26.22	11,430	DHC, Nauen, Germany	(Berlin) Weekdays after 5. Sun. after 9 p. m.
26.70	11,230	WSBN, SS. "Leviathan"	and A. T. & T. telephone connection.
27.00	11,100	EATH, Vienna, Austria	Mon. and Thurs., 5:30 to 7 p. m.
27.27	11,000	Posen, Poland	Mon. and Thurs. 5 to 6 p. m. New station testing.

Kilo-Meters	Cycles	Station	Notes
27.80	10,780	PLR, Bandoeng, Java	Works with Holland and France weekdays from 7 a. m.; sometimes after 9:30.
28.00	10,710	VAS, Glace Bay, N. S., Canada	5 a. m. to 2 p. m. Canadian Marconi Co.
28.20	10,630	PLE, Bandoeng, Java	Tests with Australia.
28.50	10,510	RDRL, Leningrad, U.S.S.R. (Russia)	
28.80	10,410	VK2ME, Sydney, Australia	Irregular. On Wed. after 6 a. m. Amalgamated Wireless of Australia, Pennant Hills, N. S. W.
		KES, Hollnas, Calif.	
30.00	9,995	Posen, Poland	
30.15	9,940	GBU, Rugby, England	
30.20	9,930	W2XU, Long Island City, New York	
30.50	9,830	NRH, Heredia, Costa Rica	10:30 to 11:30 p. m. Amado Cespedes Marin, Apartado 40.
30.61	9,790	GBW, Rugby, England	
30.75	9,750	Agen, France	Tues. and Fri., 5 to 6:15 p. m.
31.00	9,680	7LO, Nairobi, Kenya, Africa	11 a. m. to 2 p. m. Relays G5SW, Chelmsford, frequently from 2 to 3 p. m.
		Monte Grande, Argentina	works Nauen irregularly after 10:30 a. m.
31.23	9,600	LGN, Bergen, Norway	
31.26	9,590	PCJ, Hilversum, Holland	English programs Thurs. and Fri. from 7 to 9 p. m., Sat. from 5 to 7 a. m. Other languages, Thurs. 1 to 3 a. m., Fri. midnight to 4 a. m.; Sat. 1 to 7 a. m. N. V. Philips Radio, Eindhoven, Holland.
31.28	9,580	VK2FC, Sydney, Australia	Irregularly after 4 a. m. N. S. W. Broadcasting Co.
		VPD, Suva, Fiji Islands	
31.48	9,530	W2XAF, Schenectady, New York	Mon., Tues., Thurs. and Sat. nights, relays WGY from 6 p. m. General Electric Co.
		W9XA, Denver, Colorado	Relays KOA.
		Helsingfors, Finland	

(NOTE: This list is compiled from many sources, all of which are not in agreement, and which show greater or less discrepancies; in view of the fact that most schedules and many wavelengths are still in an experimental stage; that daylight time introduces confusion and that wavelengths are calculated differently in many schedules. We shall be glad to receive later and more accurate information from broadcasters and other transmitting organizations, and from listeners who have authentic information as to calls, exact wavelengths and schedules. We cannot undertake to answer readers who inquire as to the identity of unknown stations heard, as that is a matter of guesswork; in addition to this, the harmonics of many local long-wave stations can be heard in a short-wave receiver.—Editor.)

31.56	9,500	VK3LO, Melbourne, Australia	Irregular. Broadcasting Co. of Australia.
		OZ7RL, Copenhagen, Denmark	Around 7 p. m.
32.00	9,375	EH90C, Berne, Switzerland	Mon., Tues., Sat. 3 to 4 p. m.
		OZ7MK, Copenhagen, Denmark	Irregular after 7 p. m.
32.13	9,330	CGA, Drummondville, Canada	
32.40	9,250	GBK, Rugby, England	
32.50	9,230	FL, Paris, France	(Eiffel Tower) Time signals 3:56 a. m. and 3:56 p. m.
		VK2BL, Sydney, Australia	
32.59	9,200	GBS, Rugby, England	Transatlantic phone.

Kilo-Meters	Cycles	Station	Notes
33.26	9,010	GBS, Rugby, England	
33.70	8,900	Posen, Poland	Tests Mon. and Thurs. 6 to 7 p. m.
34.50	8,690	W2XAC, Schenectady, New York	
34.74	8,630	WOO, Deal, N. J.	
35.00	8,570	HKCJ, Manizales, Colombia	
35.48	8,450	WSBN, SS. "Leviathan"	
37.02	8,100	EATH, Vienna, Austria	Mon. and Thurs. 5:30 to 7 p. m.
		HSAP, Bangkok, Siam	Tues. and Fri. 9 to 11:30 a. m.
37.80	7,930	DOA, Doeberitz, Germany	1 to 3 p. m. Reichpostzentralamt, Berlin.
38.80	7,770	PCL, Kootwijk, Holland	9 a. m. to 7 p. m.
39.98	7,500	AFK, Doeberitz, Germany	
		TFZSH, Reykjavik, Iceland	
		EK4ZZZ, Danzig (Free State)	
40.20	7,460	YR, Lyons, France	Daily except Sun. 5:30 to 7 p. m.
41.00	7,310	Paris, France	("Radio Vitus") Tests.
41.50	7,220	Zurich, Switzerland	Sat. 3 to 5 p. m.
41.70	7,190	GAG, Perth, West Australia	Between 6:30 and 11 a. m.
42.12	7,280	OZ7RL, Copenhagen, Denmark	Irregular. Around 7 p. m.
43.00	6,870	EAR 110, Madrid, Spain	Tues. and Sat., 5:30 to 7 p. m.
43.50	6,900	IMA, Rome, Italy	Sun., noon to 2:30 p. m.
43.68	6,860	VRY, Georgetown, British Guiana	Wed. and Sun., 7:15 to 10:15.
44.00	6,820	XC 51, San Lazaro, Mexico	3 a. m. and 3 p. m.
45.00	6,600	Berlin, Germany	
45.20	6,635	WSBN, SS. "Leviathan"	
46.05	6,515	WOO, Deal, N. J.	
47.00	6,380	CT3AG, Funchal, Madeira Island	Sat. after 10 p. m.
48.80	6,140	KZRM, Manila, P. I.	
49.02	6,120	W2XE, New York City	Relays WABC. Atlantic Broadcasting Co.
49.34	6,080	W2XCX, Newark, N. J.	Relays WOR.
49.40	6,070	UOR2, Vienna, Austria	Testing Tues. and Thurs., 8:10 to 9:10 a. m. Wed. and Sat. after 6 p. m.
49.50	6,060	W8XAL, Cincinnati, Ohio	Relays WLAV.
		W9XU, Council Bluffs, Iowa	Relays KOIL.
49.70	6,030	W2XAL, New York, N. Y.	
49.80	6,020	W9XF, Chicago, Ill.	
50.00	6,000	EA125, Barcelona, Spain	Sat. 3 to 4 p. m.
		RFN, Moscow, Russia	Tues., Thurs., Sat. 8 to 9 a. m.
		SAJ, Karlsborg, Sweden	
		Eiffel Tower, Paris, France	Testing 6:30 to 6:45 a. m., 1:15 to 1:30, 5:15 to 5:45 p. m. around this wave.
52.00	5,770	AFL, Bergedorf, Germany	
56.70	5,300	AGJ, Nauen, Germany	Occasionally after 7 p. m.
58.00	5,172	Prague, Czechoslovakia	
60.90	4,920	LL, Paris, France	
62.50	4,800	W8XK, Pittsburgh, Pa.	Relays KDKA after 6 p. m. Works with 58W 5 to 7 p. m. Tues. and Thurs. Westinghouse Electric Co.
61.22	to 62.50 meters	4,800 to 4,900 kc.	Television. W8XK, Pittsburgh, Pa.; W1XAY, Lexington, Mass.; W2XBU, Beacon, N. Y.; WENR, Chicago, Ill.
65.22	to 66.67 meters	4,500 to 4,600 kc.	Television. W6XC, Los Angeles, Calif.
67.65	4,430	DOA, Doeberitz, Germany	6 to 7 p. m. 2 to 3 p. m. Mon., Wed., Fri.
70.00	4,280	OHK2, Vienna, Austria	Sun., first 15 minutes of hour from 1 to 7 p. m.
70.20	4,270	RA-19, Khabarovsk, Siberia	Daily except Wed. from 4 a. m.
72.87	4,116	WOO, Deal, N. J.	
80.00	3,750	F8KR, Constantine, Tunis, Africa	Mon. and Fri.
84.24	3,560	OZ7RL, Copenhagen, Denmark	Tuesday and Fri. after 6 p. m.
94.76	3,166	WCK, Detroit, Mich.	(Police Dept.)
96.03	3,124	WOO, Deal, N. J.	
98.00	3,060	Motala, Sweden	
101.7	to 105.3 meters	2,850 to 2,950 kc.	Television. W3XK, Silver Springs, Md., 8 to 9 p. m. except Sunday; WPY, Allwood, N. J.
104.4	2,870	GWF, Perth, Australia	
105.3	to 109.1 meters	2,750 to 2,850 kc.	Television. W2XBA, Newark, N. J., Tues. and Fri. 12 to 1 a. m.; W2XCL, Brooklyn, N. Y.; W8XAU, Pittsburgh, Pa.; W1XB, Somerville, Mass.; W7XAO, Portland, Ore. meters—2,650 to 2,750 kc. Television—W9XR, Chicago, Ill.
109.1	to 113.1 meters	2,100 to 2,200 kc.	Television. W8XAU, Pittsburgh, Pa.; W1XB, Somerville, Mass.; W2XCW, Schenectady, N. Y.
142.9	to 150 meters	2,000 to 2,100 kc.	Television. W2XCL, Brooklyn, N. Y. Mon., Wed., Fri., 9 to 10 p. m.; W9XAA, Chicago, Ill.; W2XBS, New York, N. Y., frame 60 lines deep, 72 wide, 1,200 R.M.P.; W1XAE, Springfield, Mass.; W8XAU, Pittsburgh, Pa.; W6XAM, Los Angeles; W2XBU, Beacon, N. Y.; W2XBW, Bound Brook, N. J.; W3XK, Washington, D. C. Daily except Sun., 8 to 9 p. m.; WPY, Allwood, N. J.
175.2	1,712	WPK, Cincinnati, Ohio	(Police Dept.)
178.1	1,684	WKDT, New York, N. Y.	(Police Dept.)
187.0	1,596	WKDT, Detroit, Mich.	(Fire Dept.)

New Radio Devices for Shop and Home

In this department are reviewed commercial products of most recent interest. Manufacturers are requested to submit descriptions of forthcoming developments.

THE "TEST-O-LITE"

A NEW device for testing circuits, which has been put on the market by the L. S. Brach Mfg. Corp. of Newark, N. J., is called the "Test-O-Lite"; a name which is very descriptive. It will be useful to any Service Man, electrician, maintenance man or engineer; and handy for any experimenter.

It has an over-all length of six inches and a width of three-quarters of an inch. Mechanically, it consists only of two heavy leads, heavily rubber-covered, and a tiny neon lamp protected by a bakelite moulding. Electrically, it is the equivalent, in some circuits, of the usual test-prod and test-lamp circuit.

The two leads of the "Test-O-Lite" may be touched to any circuit carrying the potential of 100 to 500 volts, A.C. or D.C. On D.C. circuits it may be used to check the polarity of leads; as only that end of the lamp glows which is connected to the negative side of the line.

As the test prods and lamp form a series circuit, the unit may be used in all arrangements in place of the usual continuity tester, provided the "striking" voltage is achieved.

For example, it may be used to test the continuity of power-transformer circuits; whether a power line is "alive;" whether auto spark plugs are functioning, etc.

A rough determination of a large condenser's capacity may be made by noting the brilliancy of the lamp; and the continuity of coils and circuits may be determined by using a "B" unit or the light line to supply the necessary voltage to the lamp.



Fig. B

This rotary saw equipment is especially designed for cutting large round holes through panels, etc. The circular blades are obtainable also for use with hand-operated drilling devices.



Fig. A

This neat testing unit, which incorporates prods and lamp, is about the size of two lead pencils, and gives a visible indication of voltages above 100. It is heavily protected.

To operate the tester, it is necessary to have a circuit voltage sufficient to cause the lamp to glow; this is called the "striking" voltage and its minimum value cannot be less than 100 volts.

The "Test-O-Lite" will conveniently fit in the vest pocket. As current consumption is so slight that a regular "B" battery supply may be used in testing.

A ROTARY HACK SAW

A TOOL to cut round holes in all metals, wood, plaster, fiber, or bakelite (with use of abrasives, marble, tile and porcelain may also be cut) has been developed by the Miscner and Irving Mfg. Co., Syracuse, N. Y., for the use of the radio trade.

The rotary hack saw includes a holder having either a round, straight power shank, or a Morse taper shank; and a "kit" of six blades of progressively larger diameters, in steps of 1/4-inch, ranging from a minimum 3/4-inch to a maximum of 2 1/4-inches. All of the blades cut to the same depth; which may be 1/2-inch, 3/4-inch, 1-inch or 1 1/4 inches (depending upon which kit the six blades belong to). In order to cut a hole of a given diameter, the blade having that diameter is inserted in the tool, into a slot in the holding tool having the same diameter, and locked. This holding tool is then inserted in the turning instrument; which may be a hand brace, or a slow-speed electric drill (as illustrated).

Specifications for a satisfactory drill to use in conjunction with the rotary hack saw are as follows: Capacity of chuck, 1/4-inch; no-load spindle speed, 1360 r.p.m.; full-load spindle speed, 750 r.p.m.; maximum power, 1-10 h.p. The average rotational speed of the saw should be about 150 feet of blade travel per minute.

NEW POWER TRANSFORMER

THE American Transformer Company of Newark, N. J., has developed a power transformer to meet the demand for a unit which will supply all the voltages ordinarily required for operation of a radio set in which are incorporated new type '45 power tubes.

This transformer, the "Type PF245A," has the following constants: Plate-supply winding, center-tapped, 365 volts on each

side (730 volts, total), the maximum current capacity being considered as the full output of a single type-'80 rectifier; the rectifier filament winding which is center-tapped supplies 2 amperes at 5 volts.

For two '45 tubes, a filament winding without a center tap which delivers 3 amperes at 2.5 volts is provided; another winding without a center tap supplies 1 3/4 amps. at 2.5 volts for a '24 or '27 detector tube. The fourth heater winding, also untapped, in this transformer delivers 2.5 volts at 7 amps. for the radio-frequency and first audio tubes.

Center taps on the filament windings have been eliminated to avoid complications; the center-tapped shunt-resistor method of obtaining an electrical center being considered more satisfactory.

This transformer will deliver all the current required for the grid, plate and filament circuits of the tubes mentioned above, at the correct potentials.

To maintain correct voltages at the tube-socket terminals it is necessary to use (twisted-pair) No. 18 wire for 2 amps.; No. 14 or No. 16 for 3 amps.; and No. 12 for 5 to 7 amps. The case of the transformer should be grounded, and also the center tap of the high-voltage winding, unless the tube cathodes or "A—" are grounded in the set.

A four-point switch, on one end of the power transformer, selects the correct tap on the primary for the particular line-voltage; the leads from the secondaries are brought to soldering lugs on a bakelite plate, at the opposite end of the iron casting which constitutes the mounting frame.



Fig. C

This new model of power transformer is especially designed for use in a receiver using push-pull '45 tubes, and supplies all needed current to filaments and rectifier. Center taps have been omitted in favor of the more satisfactory external-resistor method. Leads must be soldered to the terminals shown.

The "Radio Dancers"

A revived novelty which has taken Germany by storm

FOUR years ago, as a holiday novelty, Mr. Hugo Gernsback, editor of RADIO-CRAFT, conceived and published an idea for a little radio device suitable for the entertainment of children, the decoration of window displays, etc. All the constructional details were described and illustrated by him in the December, 1925, issue of *Radio News*, of which he was then editor.

It is of interest to note that a manufacturer in Berlin, Germany, has lately taken up the same idea commercially, and is now marketing a "Radio-Dancers" loud speaker in two styles. The smaller, intended principally for home use, and illustrated here, is circular, with a diameter of eight inches, and a height slightly less than three to the "dancing floor." The larger, intended for window display primarily, is rectangular, and accommodates six pairs of dancers at once.

The photographs reproduced here show the smaller instrument, which corresponds in all details with that described originally by Mr. Gernsback.

The principle of the apparatus is very simple; it is simply a loud speaker, to be plugged into a radio set. The cross-sectional view (Fig. 1) shows all the essential parts. The box, A-B-C, of bakelite composition, has attached to it a thin bakelite sheet D, which is at once the diaphragm of the speaker and the dolls' dancing floor, and is operated by a standard small magnetic speaker unit E. The railing F keeps the little dancers from falling off; the set-screws G enable the floor to be leveled. This

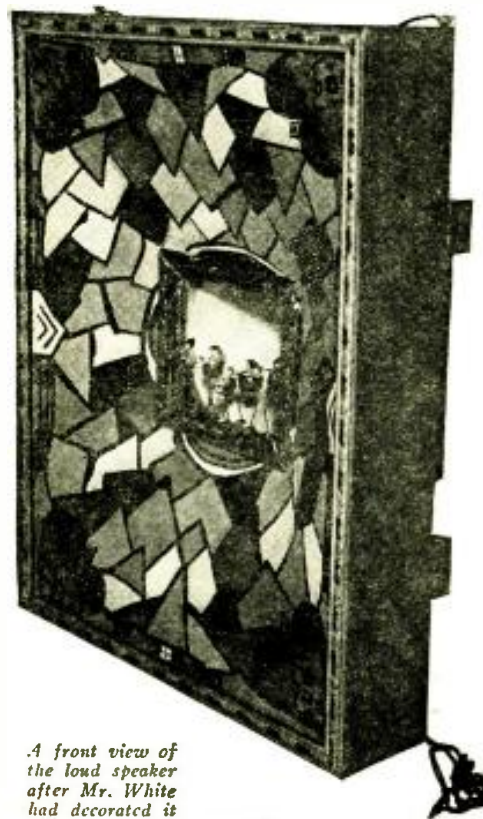

A front view of the loud speaker after Mr. White had decorated it "in the modern manner."

The "Radio Dancers" trip merrily to the tune which their "floor" is reproducing from the output of the receiver.

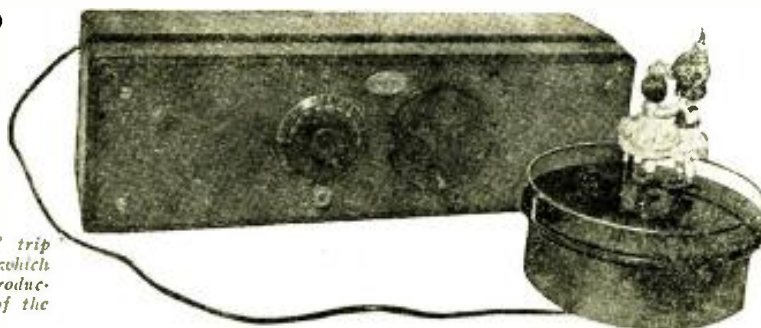

is important, as otherwise the dancers travel to the lowest point of the edge and remain there.

The dolls, which are made of celluloid, are

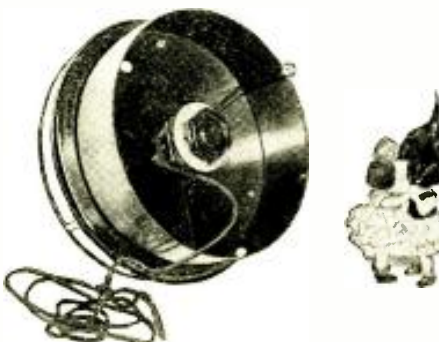

The speaker unit is beneath the diaphragm.

very light. Their feet are tipped, each with the blunt end of a common pin. The secret of successful operation is that these pins must be aligned very carefully; for, if one is even a trifle short, the dolls will not dance.

The source of their motion is found in the vibration of the diaphragm in response to the sound frequencies. The dolls, slightly jarred by the vibratory impulses, move to and fro most realistically. It is necessary that the signal be a strong one; for otherwise the diaphragm will not move sufficiently to keep the little dancers in constant motion.

It is surprising that American manufacturers have not taken up the manufacture of this instrument, which is easy to make and should find an excellent sale; particularly for window display in radio stores. In Germany it proved a sensation; for our Berlin correspondent advises us that, wherever the device has been shown, the dolls were actually mobbed by curious onlookers, and that the sale of the instrument is very brisk.

The instrument takes, of course, the place of a loud speaker and the dolls do not interfere unduly with the reproduced music. The musical volume of this loud speaker is not as good as that of reproducers of the regular types for it has been constructed, not with a view of obtaining loud sounds, but to provide enough motion for the large diaphragm.

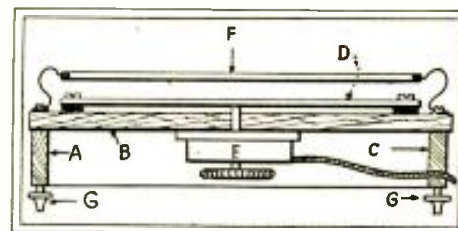

Fig. 1

A cross-section of the "Radio Dancers" floor, which is also a reproducer diaphragm. The letters are explained in the text.

A Modernistic Loud Speaker

By FRANK C. WHITE

A LOUD SPEAKER which will harmonize with the modern home furnishings can be built with no great trouble or expense. The photograph reproduced and drawings, together with the data given below, should enable even the most inexperienced to construct a reproducer of the type shown; although the builder's artistic ability is challenged by the work of final decoration.

First, assemble the frame; which is 24 inches high, 18 inches long and 7 inches deep (Fig. A). One-half inch pine or white wood stock is used for this outer frame, and the corners are nailed or screwed together. A piece of airplane cloth is now stretched across the frame. This acts as the speaker's baffle.

A small frame six inches square, made of picture molding, is next fixed to the center of the cloth; and the section enclosed by the frame is cut out. The metal frame of the speaker (an Amplion cone was used by the writer) is attached to the small inner frame (Fig. B); and the speaker chassis is drawn back as far as possible.

This completes the work on the speaker; with the exception of treating the cloth, which must be given three or four coats of dope. After the last filling coat is dry, your artistic originality must carry you on.

Buy some standard quick-drying lacquer and the particular colors desired; and draw some futuristic design or scenic effect in pencil very lightly so it will not show through when painted. Then color to suit taste and leave to dry; which will take about one half hour.

Another way of designing is to select a picture or scroll and, by the use of ordinary carbon paper, transfer the picture to the cloth. In this case, the transfer work must be done before stretching the cloth on the large frame.

Should you care to improve still further the appearance of your speaker, visit one of the many curio shops scattered about the city. You may pick up miniature dancing dolls, or musicians, as used in this speaker, for a small sum. If you are in-

(Continued on page 409)

The Cooperative Radio Laboratory

The director presents the "Last Word" in a 110-volt D.C. Electric Set, designed for low cost and economical operation

By DAVID GRIMES

IT has been our object in the past to describe in this department circuits which would be generally interesting to the radio experimenter. Yet many circuit combinations are interesting from an educational standpoint but do not give any unusual satisfaction, without tricky operating adjustments. Radio fans are willing to undertake these to some extent for the sake of performance. One of these circuit problems was the Crystal-Hybrid Receiver, previously described.

Now, we have to discuss a most interesting development which affords an opportunity for our Laboratory group to acquaint themselves with the mental processes involved in commercial research. This problem is the design of a satisfactory 110-volt D.C. receiver, for operation directly from the house-current mains in direct-current districts. Now please do not lose interest and leave us here. We know that many of you will have no use for such a receiver, for your source of power is the usual alternating current; but this discussion is as important to you as to the reader who will benefit very largely from the design presented herewith.

A Troublesome Problem

You see, in spite of all the electrification of radio receivers, the predicament of the direct-current user has been largely overlooked; perhaps because that market is not sufficiently large and again because some of the problems have not lent themselves to ready solution without an accurate tabulation of the difficulties experienced right under actual conditions. Anyway, it struck us that this condition presented an excellent

case for our laboratory experimental investigation; and many dozens of direct-current fans in the D.C. district of New York City were consulted.

Out of the maze of accumulated facts, certain definite conclusions were drawn, which must be right, because these fellows actually had to design their own installations for their own radio satisfaction. Incidentally, about as many circuits were brought to light as there were D.C. fans interviewed.

It became increasingly obvious that direct-current operation is possible if enough money is to be expended and enough power consumed after the installation expenditure.

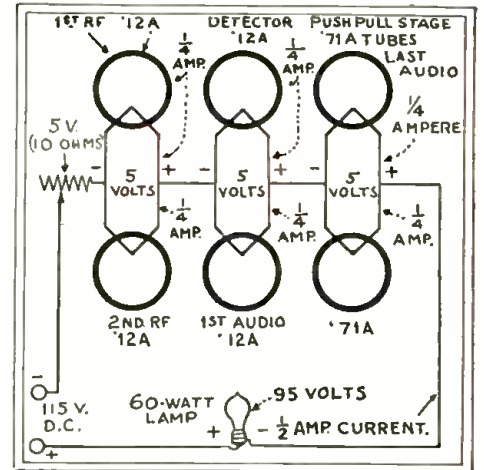

Fig. 1

All voltage drops in this receiver are utilized to provide "C" bias for its tubes. Efficiency!

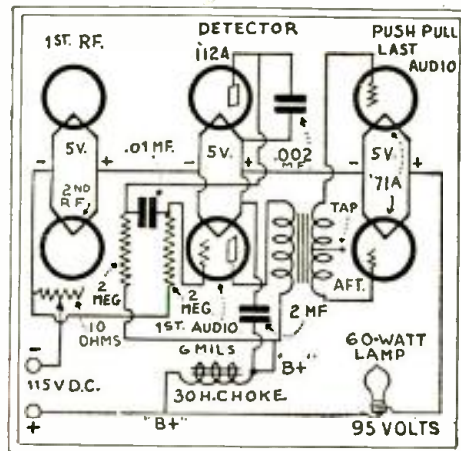

Fig. 3

The filter circuit used to suppress generator ripple in the D.C. receiver. An old transformer secondary will serve as the choke.

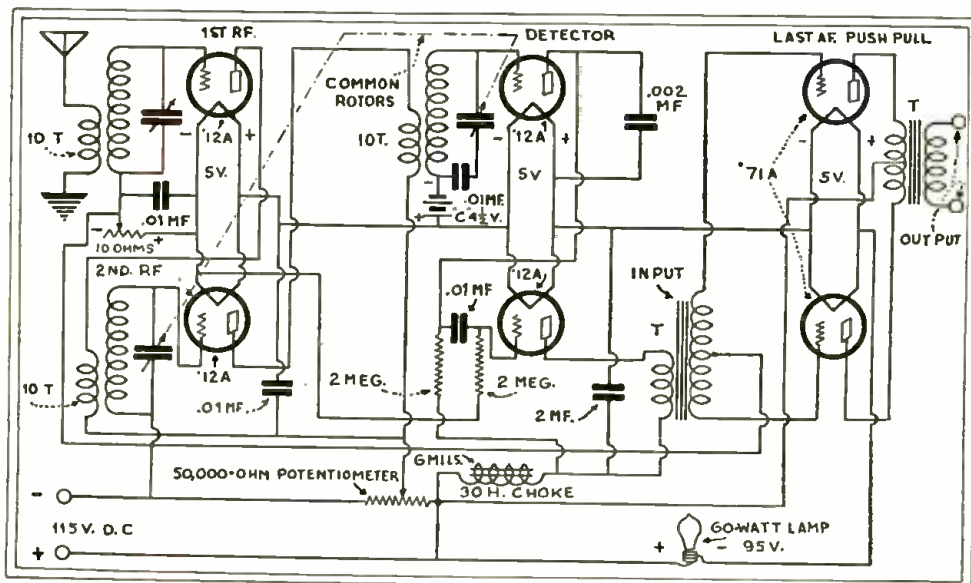

Fig. 6

The complete circuit of the D.C.-operated receiver described in this article; it looks complicated, but every part of it has been separately described in detail, in the preceding figures. This set will give excellent quality, and is easy to operate.

But such a solution does not appeal to a laboratory for, after all, almost anything can be accomplished if enough money is expended, and it does not take a great deal of engineering brains, either. Our problem is to analyze the direct-current requirements and the difficulties confronting us, and then to proceed to the answer involving the least of expense. There have been, and are, commercial receivers for 110-volt direct current; most of these are costly and are extremely hard on the electric meter. Complicated filters have been installed in various parts of the circuit with little rhyme or reason.

Here are some of the facts which cannot be overlooked. There is available only 110 volts—no more, no less. Power transformers will neither step up the voltage for a so-called adequate plate supply nor step it down for satisfactory filament operation. The various "B", "C" and "A" supplies must be obtained from this rather inflexible source. Next, it will be a revelation to some of you to learn that direct-current lines are far from quiet; in this regard, they are far different from batteries. The commutator of the D.C. generator creates a bad tone, or "ripple", at a frequency which is exceedingly aggravating because its pitch is around that point to which the ear is most sensitive. In this respect, the problem is a little more difficult than the usual 60-cycle filtering.

Tube Types Available

The first circuit problem worth considering involves the economical heating of the filaments. The old storage "A" battery, delivering pure direct current, called for no special considerations. When alternating current came into use for lighting the filaments, it was found that the ordinary tube cools off between alternations of the heating current to such an extent that the electronic emission increased and decreased accordingly. This caused a bad hum in the plate

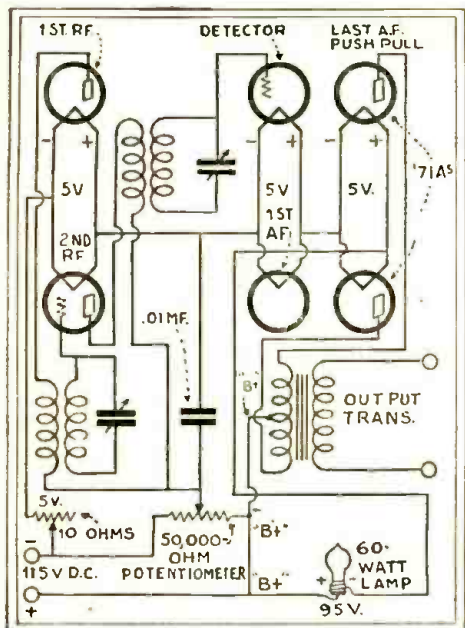

Fig. 2

The potentiometer across the light line regulates the R.F. tubes and controls volume.

circuits. The same situation obtains when the 110-volt D.C. lines are employed, because the alternating ripple from the generator commutator rides on top of a direct current. The average tone affects the plate current, causing an audible hum in the reception. This naturally led to the same answer that has been applied to the 60-cycle problem—the heater-type tube.

The idea is sound, but the '27 tube is not the solution. First, because its great thermal lag is not required to maintain constant

filament emission, with the higher frequency of the commutator fluctuations; and, secondly, because it requires altogether too much current to be economical in a D.C. set. The '12A here comes to our rescue; this tube, which never seemed to find any extensive application because of its early replacement by the superior '71A as a power tube, is an ideal one for the radio, detector, and audio stages of our D.C. set. This tube has an appreciable thermal lag—several seconds in fact. Not the half minute or so of the heater tube, it is true, but sufficient to completely eliminate the commutator hum which might otherwise arise from this source.

Reference should here be made to Fig. 1. This shows the complete layout of a most satisfactory circuit for D.C. operation. It will be noted that '12A tubes are used in all stages except the last audio, where the conventional '71A power tubes are used in push-pull. The several filaments are connected in a series-parallel combination which delivers one-quarter ampere to each tube, and draws a total of one-half ampere from the line. As the voltage of the D.C. line is many times higher than the few volts required to light the filaments, we must rely on a current-limiting device; so that the filaments receive their proper current in spite of the high line-voltage. Such a device is the 60-watt lamp shown. The 10-ohm rheostat, included in the extreme negative end of the filament circuit, permits a slight adjustment for variable line-voltages and, at the same time, regulates the amount of negative "C" bias on the radio-frequency stages, as described later on. So much for the filament circuit.

The source of "B" supply is next in order. A study of the requirements will explain the location of the 60-watt lamp in

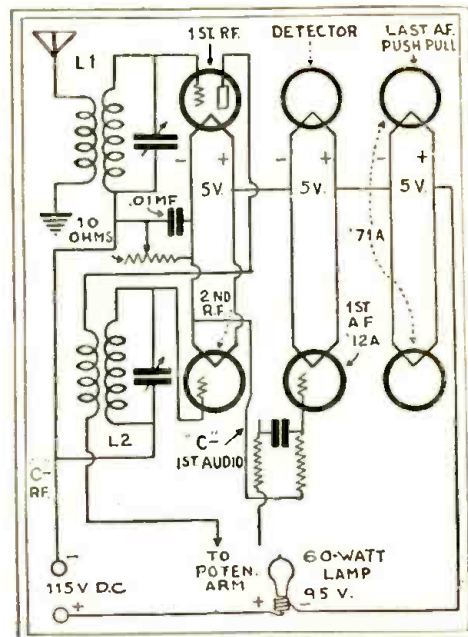

Fig. 4

The first audio tube takes its "C" bias across the R.F. filament circuits; the R.F. tubes across the rheostat.

the positive end of the filament circuit. By connecting the "B+" lead of the push-pull stage to the extreme positive end of the house mains, we will have an available voltage between the plates and the filaments equal to the voltage drop across the 60-watt lamp. You see, this lamp really serves two purposes, other than the illumination derived from it; the first of which is to limit the current for the filaments and the second, to create a difference of potential

(Continued on page 414)

One Hundred Dollars in GOLD for a SLOGAN for



A few moments of your spare time NOW may bring you \$100.00 in GOLD!

WE want a catchy slogan for this magazine. Slogans are now used universally in many different lines of business, and we believe that this magazine should be known by its own slogan.

Such slogans as "NOT A COUGH IN A CARLOAD"; "GOOD TO THE LAST DROP"; "SAY IT WITH FLOWERS," etc., are well known. A number of magazines have already adopted slogans; such, for instance, as "Popular Mechanics," with "WRITTEN SO YOU CAN UNDERSTAND IT."

We are offering \$100.00 for a novel, as well as descriptive, catchy phrase which we shall use after the end of the contest as a permanent slogan of this magazine.

REMEMBER, THERE IS NOTHING TO BUY OR TO SELL!

You have an equal chance to win this prize, regardless of whether or not you are a subscriber. The contest is open to all. Get your friends in on this and, if they give you suggestions, you may split the prize with them, if you so desire.

To win the \$100.00 prize, you must submit only a single slogan, ONE ONLY. It must be an original idea. It makes no difference who you are or where you live, whether in this country or not; anyone may compete in this contest and you may be the winner.

Look this magazine over carefully and try to find out what it stands for, what its ideals are, and what it tries to accomplish. Then try to put all of your findings into a slogan which must not, under any circumstances, have more than seven words.

After you have the idea, try to improve upon it by shortening the slogan and making it sound more euphonious; but always remember that it is the idea which counts. The cleverer the slogan, and the better it expresses the ideas for which this magazine stands, the more likely are you to win the prize.

No great amount of time need be spent in the preparation of

slogans. Start thinking right now and jot down your thoughts. Also, tell your friends about it, and get them to submit slogans of their own; or compose one in partnership with them.

Here are a couple of sample slogans; which are given as mere suggestions, AND NOT TO BE USED AS ENTRIES:

"WAVES OF RADIO INFORMATION"
"IT HOOKS UP THE RADIO MAN"

RULES FOR THE CONTEST

- (1) The slogan contest is open to everyone except members of the organization of RADIO-CRAFT and their families.
- (2) Each contestant may send in only one slogan; no more.
- (3) Slogans must be written legibly or typed on the special coupon published on page 403 of this magazine. (If you do not wish to cut the magazine, copy the coupon on a sheet of paper exactly the same size as the coupon.) Use only ink or typewriter; penciled matter will not be considered.
- (4) Each slogan must be accompanied by a letter stating in 200 words, or less, your reasons for selecting this slogan.
- (5) In case of duplication of a slogan, the judges will award the prize to the writer of the best letter; the one which, in their opinion, gives the most logical reasons for the slogan.

This contest closes on May 1, 1930, at which time all entries must be in this office; and the name of the winner will be announced in the July, 1930, issue of RADIO-CRAFT, on publication of which the prize will be paid.

Because of the large number of entries which may be expected, the publishers cannot enter into correspondence regarding this contest.

Address all communications to:

Editor, Slogan Contest

Care of RADIO-CRAFT

96-98 Park Place

New York, N. Y.

The Radio Craftsman's Own Page

In these columns will be found letters of RADIO-CRAFT readers from every quarter of the globe. Here old friends will renew acquaintances of long standing.

PASS A LAW!

Editor, RADIO-CRAFT:

This is just a suggestion that may help radio. Why not have a law passed that would compel radio manufacturers and builders of home radio sets to place a coil and condenser in the aerial system of their sets, to sharply tune them to some wavelength not in use when the set is shut off? That would prevent the thousands of acrials absorbing power from the passing waves when not in use.

Eight or nine years ago we could enjoy programs from 500-watt stations almost anywhere in the United States; but now there is hardly a whisper. If this is not the cause, please tell me why.

BRYAN ZEIGLER,
Boyer City, Michigan.

(Even if this were the cause of the trouble, we fancy that the enforcement of such a law would be a difficult task. However, the loss of signal strength by absorption in tuned aerial circuits, even in the most congested conditions, is very small, as compared to that occasioned by metal buildings, railway lines, light wires, etc., etc. This is shown by the surveys of station strength around large cities, conducted a couple of years ago by the Department of Commerce. Most commercial receivers, nowadays, have aerial circuits which are not tuned in the broadcast band. Our correspondent will have to blame weakened reception on the enormous multiplication of stations, and of sources of electrical interference, in the past eight years, as well as on the "sunspot period."—Editor.)

POOR PARTS CAUSE TROUBLE

Editor, RADIO-CRAFT:

Recently, I wrote you for information on the "1930 Receiver," saying I had built it but it was dead. I have since found part of the trouble. Both of the resistors in the detector and R.F. circuits were open. I could not get Electrad "Truvalts" as specified, so had to use some wound on cardboard. These were perfectly O.K. when I tested them; but in order to fix them to the parts, I had to solder them. As soon as the heat was applied, the cardboard shrank, and loosened the ends of the wire, which came away from the terminals. It was so small that it was difficult to see. I can now get local stations with fair volume by putting the phones across the primaries of the audio transformer; but cannot do so unless I take out the small coil from the aerial circuit. In the diagram, this shows one end grounded. I am wondering if this is correct. Now that I am satisfied that there is nothing radically wrong and that the set will work all right when I have finished, please disregard my previous letter.

J. A. MOSS,
277 Mayfair Ave.,
Montreal, Canada.

(The circuit as shown is correct; and if the constructor has followed directions, made good connections, and used good apparatus, he should be more successful.—Editor.)

SHORT-WAVE BROADCASTS

Editor, RADIO-CRAFT:

W2XAL broadcasts the regular evening programs of WRNY on Mondays, Tuesdays, Fridays and Saturdays after 6 p.m., Eastern Standard Time, until sign-off of WRNY. They also broadcast test programs on Tuesdays, Thursdays and Saturdays from about 11 p.m. to 1 a.m. The frequency used is 6040 kilocycles. They expect to test soon on their other frequencies, which are 11,800, 15,250 and 21,460 kilocycles.

W2XV of the Radio Engineering Laboratories, 100 Wilbur Avenue, Long Island City, N. Y., is broadcasting experimental programs on 8650 kilocycles. The programs will be on the air on Wednesdays and Fridays 8 to 10 p.m., E. S. T.

W9XF of the Great Lakes Broadcasting Company, Chicago, broadcasts on 6020 kilocycles. The schedule is the same as WENR. They are also authorized to broadcast on 11,800 and 20,500 kilocycles.

W2XBIH of WBBC and WCGU is broadcasting the evening programs of those stations on 5500 kilocycles.

WSBN came in here loud on about 70 meters;

WOO the other station on the circuit came in at about 75 meters.

KKQ, Bolinas, Calif., I received several afternoons after 5. E. S. T. They were calling K10. The wavelength that was announced was 25.105 meters.

It is more truth than poetry that you can not use any tube but one similar to the Arcturus 227 in short-wave adapters. Now I have trouble with motorboating on very few portions of my tuning range; even there I have to only cut down on the "B" voltage.

I received the new Mexico City station but I will not try to guess the call letters (ND4). My reception was all near the noon hour, at good speaker volume with little fading.

The Chicago Federation of Labor has started to broadcast on the short waves again. The short-wave station is W9XAA on 6,080 kilocycles. They are only broadcasting test programs at present, but expect to be on a regular schedule soon. They will broadcast the regular evening broadcasts of WCFL.

HOWARD L. GOUDY,
633 Cornelia Ave.,
Chicago, Illinois.

BAND-PASS FILTERS

Editor, RADIO-CRAFT:

My application for a two years' subscription, together with money order, is enclosed. A few copies of RADIO-CRAFT, purchased at the newsstands, convinced me that I wanted it. May I include that it seems to contain what recently seems to be lacking from other radio publications—an editorial personality who so impresses himself on his readers that they feel as if they knew him personally.

We would like to hear about band-pass filters, their good points, bad points, and are they going to become standard equipment in the radio of the future? Why is it that the screen-grid Strobodine has never been mentioned in publications? The writer built one after the publication of the circuit in *Radio News*. It is an acknowledged superior performer in our vicinity over any commercial radio that we have ever tried. Here's best wishes to RADIO-CRAFT.

H. C. PENDERGAST,
Box 35,
Winslow, Maine.

(Our correspondent will observe increasing attention to the band-pass filter in our constructional pages. It will be increasingly necessary.—Editor.)

CORRESPONDENTS WANTED

Editor, RADIO-CRAFT:

I am a subscriber, and find every issue excellent. I would like to correspond with RADIO-CRAFT readers all over the world, to know how reception is under different climatic conditions.

LOUIS BLOOM,
253 Euclid Ave.,
Toronto 3, Ont., Canada.

Editor, RADIO-CRAFT:

I am here in Monroe for a while, and trying out the climate of Louisiana on short waves. If any of the boys would like to hear from me, I will tell them a lot of things of interest to them in short-wave transmitting. I have had everything that has a call to it; I have constructed two television sets and got good results.

RAYMOND BONNER,
412 Desiard St.,
Monroe, La.

Editor, RADIO-CRAFT:

I have constructed the Pilot "Wasp", and have received 48 short-wave and 21 long-wave stations. If any of your readers would like to exchange ideas and experimental data, I will answer any letters. I think your magazine is the best for the experimenter and the service man.

W. H. NILSSON,
19 Seventh St.,
Savannah, Georgia.

(We shall be glad to put in touch with each other as many readers as possible; if the number of inquiries increases, beyond the present number, it may be necessary to simply tabulate them under "Correspondents Wanted."—Editor.)

HARMONIC HETERODYNES?

Editor, RADIO-CRAFT:

NRH, Heredia, Costa Rica, is now on, and has been for some time, from 10 to 11 p.m., E. S. T., every night on 30.9 meters.

PCJ is being heterodyned badly by K1JZ at Fort Worth; the eighth harmonic of this station falls right on PCJ and mashes up their whole program. This is being noticed in all parts of the country.

A letter from VRY, Georgetown, British Guiana, says that their schedule is Sundays and Wednesdays at 7:15 p.m., E. S. T.; they keep on until about 9:30. Their wave is 43.86 meters. Lately, they are being interfered with by a commercial code station. They also state that they will be on the air shortly with more power and would appreciate reports from all listeners.

A new one heard here on Oct. 26 and 27 was F8UZ, Rue de Pecher, Montelimar, France. He was working on 38.56 meters, using phone from about 6 to 9:30 p.m., E. S. T. He has been heard several times since; working also on 22.1 meters with G2GN. I think that this is the first time it has been reported in the U. S.

I have read every issue of RADIO-CRAFT since it started, and find it is getting better as it goes along. Keep up the good work.

CHARLES J. SCHROEDER,
3125 N. Spangler St.,
Philadelphia, Pa.

A FAMILY HOBBY

Editor, RADIO-CRAFT:

Please publish some more circuits like the "Junk-Box": I have built it and have received PCJ, G5SW, GBS, KGO, W8XAL, W2NE, KDKA, WGY, all with good volume. I have been experimenting with a set using 5-plate condenser and two stages of resistance-coupled amplification. I have received with it the above stations and W9XF, CJRN, WND.

I am thirteen years old, and have been a radio "bug" for two years. My grandfather and I have a telegraph line between our houses, which are near each other.

PAUL H. LEE,
252 Genesee Park Drive,
Syracuse, N. Y.

(Readers will find in the "Craft-Box," published in the October issue of RADIO-CRAFT, a simple and inexpensive set, utilizing, however, a screen-grid R.F. stage ahead of the detector. Where local interference is not troublesome, and location is good, a simple regenerative short-wave set, with one or two stages of amplification, gives very good results for the experimenter. Where the problem is harder, the new screen-grid designs, though more expensive, should be used for best results; and complete shielding is often advisable. It is interesting and pleasant to note the cooperation the youthful experimenter describes in this letter. We trust there are many more such cases.—Editor.)

PHILIPPINE BROADCASTING

Editor, RADIO-CRAFT:

KZRM, Manila, P. I., now operates a transmitter on 6130 kc., 48.8 meters; the output is one kilowatt, though it sounds like fifty here. The call is K1XR. The hours are from 4 to 5:30 p.m. every day except Sunday, when they are 3 to 4; and from 6 to 10 or 11 p.m. every night except Monday, Manila time. (This is 13 hours faster than Eastern Standard Time; the corresponding hours are 3 to 4:30 a.m., 2 to 3 on Sundays, and 5 to 9 or 10 a.m., of the same day, E. S. T.) This information is from their letter of confirmation. The station can be heard here with abundant loud-speaker volume and remarkable clearness every morning.

C. H. LONG,
Clifton, Texas.

HINT TO BUILDERS

Editor, RADIO-CRAFT:

I ran across a station on 68 meters giving WFCT as call; he said he was 800 miles out of New York. Later he was using code. (Apparently a ship.)

(Continued on page 398)

RADIO CRAFT KINKS

The two readers of RADIO-CRAFT who send in the greatest number of ingenious Kinks each month will be awarded, each, a copy of "The Radio Amateur's Handbook," a work well known for its value; in addition to the space rates paid for all articles printed.

A "CROSLLEY V" OSCILLATOR

By Walter I. Warner

ALTHOUGH thousands of 2-tube "Crosley V's" were sold, how many service men have realized how easy it is to make one into an excellent oscillator for circuit balancing, etc., by a slight change in the wiring? The circuit for this purpose is shown in Fig. 1.

A Hartley-type oscillator was decided upon, using a type '99 tube for V1. Condenser C1 is the regular "book-type" unit in the receiver; C2 the regular .00025-mf. condenser in shunt with grid leak G1; C3 a 0.5-mf. condenser; the rheostat 30 to 50 ohms. A 4½-volt "A" battery and a 45-volt "B" battery were used.

Audio-frequency modulation may be obtained by using a variable high resistor for G1, and adjusting it to the proper value.

grid resistors R1-R2. This lead, in practically every instance, runs to a "C—" post on the connection strip; consequently, this change connects the "C" battery to the grids of the two push-pull tubes, through the resistors. The "F—" post of the A.F. transformer connects to R2, and the "G" post to R1.

When '71A tubes are used as V1 and V2, it is recommended that a protective output unit be employed; this is shown as a high-impedance choke coil used with a 2- to 4-mf. condenser, C1.

(It must be remembered that added "B" current must be available to maintain the plate voltage on the power tubes. Otherwise, two '12A's might be used instead of one '71A, with better amplification.—Editor.)

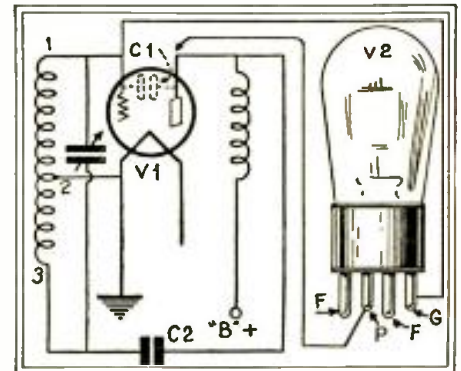

Fig. 3

The burnt-out tube at the right has the same capacity as V1, and therefore is an ideal neutralizing condenser.

A PUSH-PULL ADAPTER

By Louis Rick

AN easily-built unit, using a generally-known circuit, to change a final stage of audio-frequency amplification to push-pull operation, may be made by the use of resistors and sockets; as shown in the sketch (Fig. 2).

A list of parts includes: One UX-type tube base, for a plug; two sub-panel-type UX sockets, V1, V2; four sets of mounting clips, for four resistors; two 100,000-ohm resistors, R1, R2; two 50,000-ohm resistors (heavy-duty type), R3, R4; one 4 x 4 x 3/16-in. piece of bakelite. The suggested layout is shown in the figure at A.

Insert the adapter-plug, with the associated parts wired to it, into the last audio-tube socket; disconnect the "F—" lead from the last audio-frequency transformer (that ahead of the socket) and connect it instead to the center connection between the two

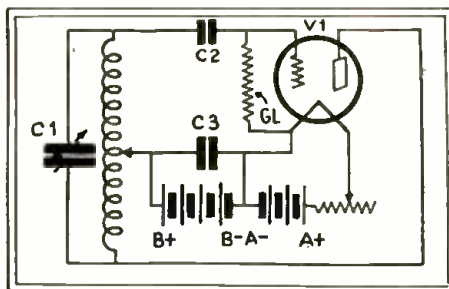

Fig. 1

The old regenerative sets, now junked, supply exactly the parts required for an R.F. oscillator.

A CONVENIENT METHOD OF NEUTRALIZING

By Boris S. Naimark

IT is not generally known that two tubes of similar characteristics have exactly equal grid-to-plate capacities. (Any difference that may exist is so small as to be difficult of measurement.)

This immediately suggests that, if we have

a set employing, say, type '01A tubes, in the radio-frequency stages, we can use burnt-out '01A tubes, whose grid and plate elements are not shorted, as neutralizing capacities to take the place of a regular neutralizing condenser.

Referring to Fig. 3, it should be quite apparent that, if point 2 in the tuned circuit (at left) is the exact electrical center of the grid inductance, stability is obtained only when the value of the capacity C2 is exactly equal to the value of the inter-electrode capacity C1. In such a circuit arrangement a burnt-out tube V2 (of the same type as V1, and whose grid and plate electrodes are intact) will constitute an ideal neutralizing condenser C2 and will require no adjustments to achieve stability.

Use a socket, or solder the leads directly to the grid and plate prongs of V2—the "neutralizing tube."

(The exact position for tap 2 must be determined by experiment. It will be approximately at the mechanical center—as seen or measured.)

The advantages of such an arrangement, wherever the set design permits, are as follows: (1) Low cost, since burnt-out tubes may be used; (2) no capacity adjustments are required, since the grid-to-plate capacity of the neutralizing tube is just right; (3) permanence, since the grid and plate electrodes within the glass bulb form a moisture-proof condenser of the highest type possible to obtain.

A SIMPLE REMOTE-CONTROL

By Bert M. Freed

ONE of the simplest means for turning on or off a radio set is to use an ordinary "radio relay," of a once popular type, now obtainable for a very small sum. Such an instrument has a switching circuit which,

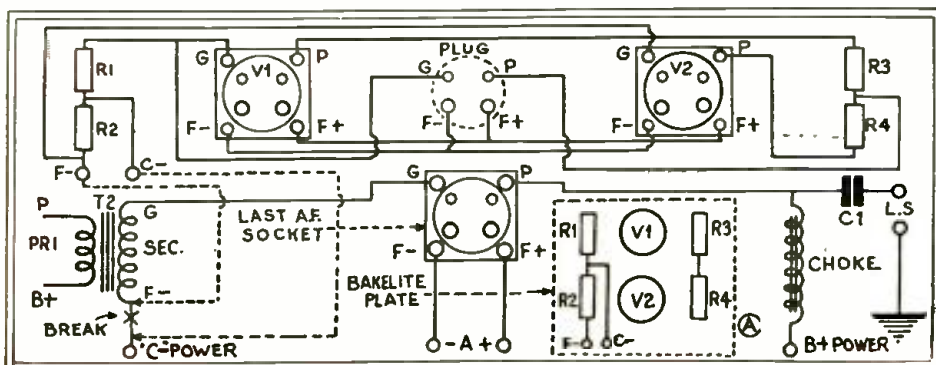

Fig. 2

The circuit shown above, plugged into a power-tube socket, constitutes a resistance coupled push-pull stage. It may be mounted on a small square of bakelite, laid out as shown at A, lower right, attached to a tube base.

normally, would put a "B" eliminator on the lighting circuit when the radio set is turned on. When the set is turned off the relay, ordinarily, would connect a charger to the storage "A" battery. In other words, the switch is one of the double-pole, double-throw type.

However, when such a relay is to be used with an A.C. set in the suggested remote-control layout, the line-plug of the A.C. set is inserted into the relay receptacle marked "B" Elim. The two binding posts (marked "A" from radio set, and "A" from battery") then become connections for the two remote-control leads, which may be run to any point desired (Fig. 4, next column).

Although, for simplicity, only a single remote-control point is shown, a little thought will show how any number of switches, connected in parallel, may be installed to operate the relay. (The writer uses only one switch.)

In the relay-control circuit are shown a little "C" battery and an ordinary 6-volt pilot lamp. The lamp passes just enough current to operate the relay and thereby limits the drain on the battery; in addition to acting as a visual indication that the set is on or off.

The "line-plug" of the relay is plugged into the light-line.

The normal positions of the relay contactors are shown in solid lines; and the positions taken by them, when remote-control switch is closed, in dotted lines.

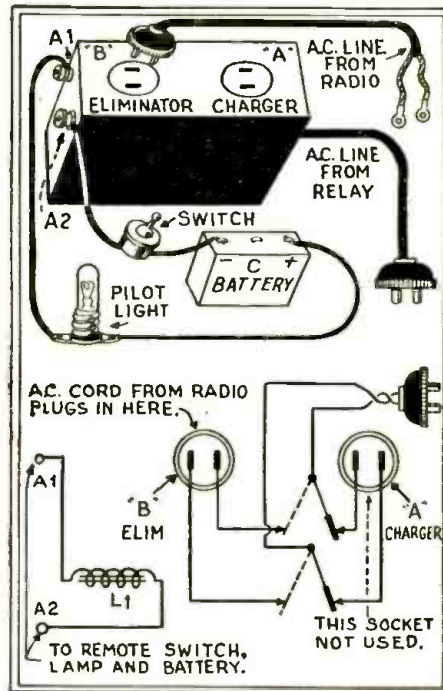

Fig. 4

There are many old set-charger relays, discarded by owners of electric sets, which are well adapted to provide remote-control devices for turning the set on and off.

EMERGENCY MEASURES

By Helmers J. Huebner

IT may interest readers to know that temporary operation of a radio receiver may frequently be obtained by running a lead from its aerial post to a lighting switch plate or outlet plate on the wall or base-board. The lead wire is merely stuck under the plate and the plate tightened down (Fig. 8A).

The explanation lies in the fact that the armored light line is grounded to the outlet box, to which the outlet plate is screwed. The armored line often picks up sufficient radio-frequency to operate a good radio set satisfactorily.

Another "kink" of the writer is to wind around the two lamp conductors a few feet of insulated wire, which is connected to the antenna post of the radio set (Fig. 8B).

In "my country," the ground is often so dry that wire fences are very well insulated; and good signal strength results when a lead is run from the fence to the radio set. Better results are secured in this way than when the same lead is "dead-ended" at the fence.

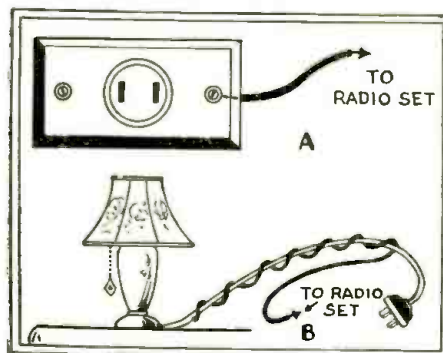

Fig. 8

The pick-up from the light-line, obtained in either of the coupling methods shown above, will often give excellent reception and obviate the trouble and expense of an aerial.

A NOVEL HOWL-ARRESTER

By C. J. Cairns

NOT being able to obtain a howl-arrester when needed, the writer improvised the one shown in Fig. 6.

It was made by cutting off the lower half of a hydrometer bulb, as indicated by the dotted lines. The upper part then just slipped over the microphonic tube.

These bulbs may be obtained in "five-and-ten" stores.

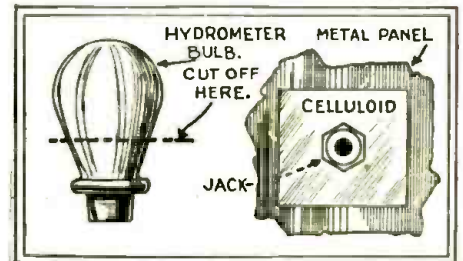

Fig. 6

Fig. 7

At the left, a simple means of obtaining a tube-cap to stop microphonic noises. Right, a handy means of insulating parts from a metal panel.

AUTO CURTAIN AS INSULATOR

By Arthur Bernd

AUTOMOBILE curtains are made of an excellent grade of celluloid, which the writer puts to use, when cut and trimmed to size and shape, as insulation in his radio set. A single sheet will last for years. In Fig. 7 a flat "washer" is shown, insulating an output jack from a metal set-panel. Strips may be cut and curled around a shaft which is to be insulated.

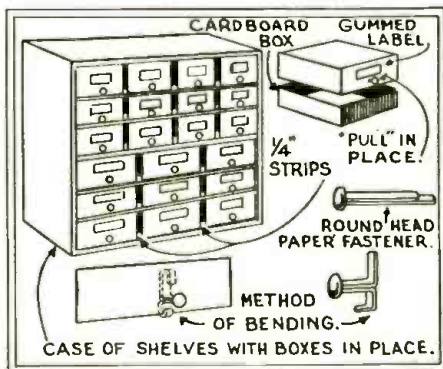

Fig. 5

The cabinet here shown provides a place for everything; yet it is made of paper boxes, etc., which would otherwise be thrown away. Small wooden strips will serve instead of partitions, as shown.

AN INEXPENSIVE SMALL-PARTS STORAGE CABINET FOR THE AMATEUR

By Lester P. Young

MANY experimenters like to "file" their radio small parts. Stationers often throw away convenient-sized boxes of the type illustrated; and the writer finds them handy for this purpose. A couple of dozen of these cardboard boxes of varying depth may be fitted into shelves spaced to fit the tiers, as they are placed in a wooden packing case of correct dimensions.

To prevent the boxes from binding, and insure their sliding in the proper place, dividing strips made of 1/4-inch square wood are nailed to each shelf, between each pair of boxes.

Ordinary round-headed brass paper fasteners may be used to make a practical and good-looking "pull" (Fig. 5, above).

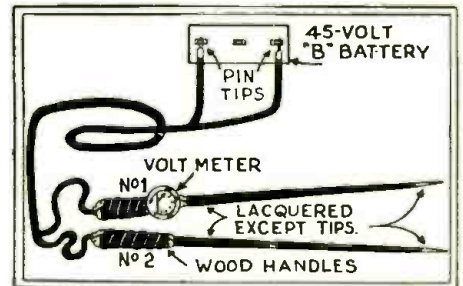

Fig. 9

The tester thus made measures resistances and determines continuity very quickly. By omitting the battery, it may be used also for voltage readings up to its scale limit.

MODERNIZING THE ICE-PICK

By Luther C. Welden

A CIRCUIT tester, which the writer finds a great convenience, was quickly made by mounting a 0-50-scale voltmeter on one of two ice-pick handles. All but the tips of the picks were insulated with a coat of lacquer. A "double-conductor" loud-speaker cord was soldered to the steel of one pick; and to one terminal of the meter on the other (the other terminal of the meter being soldered to the pick on which it was fastened). Tape was used on the handles to securely hold the cord leads and meter. (It was necessary to use a loud-speaker cord of the "fine-wire" type; for the old "tinsel" kind is not sufficiently conductive or strong.) The assembly is shown in Fig. 9.

The remaining two ends of the cord are connected to a 45-volt "C" battery.

INFORMATION BUREAU

SPECIAL NOTICE TO CORRESPONDENTS: Ask as many questions as you like, but please observe these rules:

Furnish sufficient information, and draw a careful diagram when needed, to explain your meaning; use only one side of the paper. List each question. Inquiries can be answered by mail only when accompanied by 25 cents (stamps) for each separate question. We cannot furnish blueprints or give comparisons of the merit of commercial products. The reader asking the greatest number of interesting questions, though they may not be all answered in the same issue, will find his name at the head of this department.

Highest for the current month: PERRY N. DALY with eight interesting questions.

CROSLY "RFL-90"—CARTER ADAPTER

(42) Mr. John A. Garriott, Little York, Ind.
 (Q.) Having had difficulty in servicing a Crosley model "RFL-90" receiver, I am writing for advice. It is connected right, I am sure, although the receiver will run down a set of "B" batteries in a few weeks; the 45-volt block that feeds the detector being the first section to go. Changing tubes and by-pass condensers has not improved matters.

(A.) The schematic circuit of this receiver appears in these columns.

There are several possible causes of the trouble mentioned. Of course, the first step is to connect a 0-10 milliammeter (fused or otherwise protected) in the plate circuit of the detector, between the "B+45" set binding post and the battery, and note the current drain. If this is above normal, the leakage may then be checked off as being due to either a leaky by-pass condenser, C7; a leaky A.F. transformer (primary winding partially grounded to a point of lower potential, such as the case, or the secondary); or a defective detector tube socket. If the reading is below normal, the trouble may be due to a leaky battery cable.

Considerable economy will be effected if a separate 45-volt "B" block is used for the detector plate supply. The negative terminal connects to "A+" just as does the negative lead of the four 45-volt sections which supply the potential of the remainder of the set. The plus tap of the single 45-volt section is connected to the "B+45" binding post of the receiver.

There is a possibility that the "C" connections are not correct; although this should seemingly have little to do with the detector plate supply. A "C" battery which is reversed, or "poled" wrong (wrongly marked), would cause almost the same trouble as described.

(Q.) How does the Carter type "PC-28" phonograph adapter connect to the radio set? Please indicate wire colors.

(A.) The schematic circuit of this adapter is shown herewith. It will be noted that a tube inserted into the adapter socket does not function as either detector or amplifier, but merely as a coupling device, when the switch is thrown to the adapter. The tube is indicated as a dotted circle, and the detector socket as a dotted square, in Fig. B.

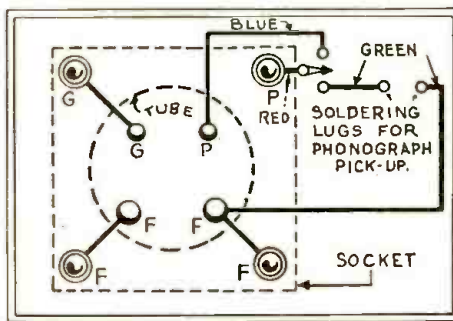

(Q. 42B) Circuit arrangement of the Carter "Type PC-28" phonograph adapter.

A STANDARD SET — SHIELDING — SCREEN-GRID

(43) Mr. L. T. Hogan, Jr., Columbia, Mo.

(Q.) When using a receiver with the schematic circuit shown, I cannot get more than three or four stations, at points above 40 on the dial; although a great many stations can be heard below this point. Above the 40 setting, the circuit goes into violent squealing. Please suggest a remedy.

(A.) In the circuit mentioned, reproduced in these columns, certain changes have been indicated. At X1 and X2, insert resistors of 500 to 1,000 ohms value. Break the grid-return lead of T2 at X3, and make provision for the "C-Power" connection shown in dotted lines. Break the plate circuit of V5 at X4, and run the lead (shown dotted) labeled "B-Power."

Next, wire in a 2- or 4-mf. condenser, shown as C2. Another fixed condenser, C3, with a value of 2-mf., is to be connected as shown. The action of these condensers is to stabilize the receiver through by-passing of the circuits which, during operation, are varied in characteristics.

It is suggested that the positions of the coils be carefully considered. It is possible that turning one coil at right angles would very greatly reduce circuit coupling and thus improve operation.

Use a value of about .001-mf. for C1. Also, increase the length of the aerial.

If the rotor and stator plates of the variable condensers touch at any point above 40 on the dial, this would explain the lack of all but strong signals.

It is not stated whether the variable condensers are "ganged" for single-control operation. If they are, it is probable that the tuned circuits do not stay in resonance throughout the tuning range.

(Q.) Would shielding improve the operation of this receiver?

(A.) Shielding might improve this receiver; but whether it proves successful depends upon the efficiency with which the shielding of the receiver was carried out. It is so much easier to reduce rather than increase, the efficiency of a receiver by shielding, that we do not recommend the attempt with this receiver. In the first place, it would be advisable to change the radio-frequency transformers, and this immediately leads to undesirable complications.

(Q.) What are the circuit changes necessary to improve this receiver by the addition of screen-grid tubes?

(A.) This idea, too, we cannot recommend in connection with this receiver. It requires even more extensive changes than shielding; for shielding is one of the necessary steps toward practical use of screen-grid tubes.

Another objection is that the coils in the plate circuit of the screen-grid tubes must have considerably higher inductance (greater number of turns) than such coils designed for ordinary tubes of the 01A type.

The design and construction of units to be used with screen-grid tubes has been discussed at considerable length in many articles which have appeared in past issues of RADIO-CRAFT magazine. The electrical connections to the actual tube are simple.

Before plugging in a screen-grid tube all wires are removed from the "G" post of the socket; then, a wire is run from this "G" post to a 45-volt tap on the "B" supply. After the tube has been plugged into the socket, the final step is to fasten to the "cap" (on the top of the screen-grid tube) the lead that previously was taken from the "G" post on the tube socket. Note the by-pass con-

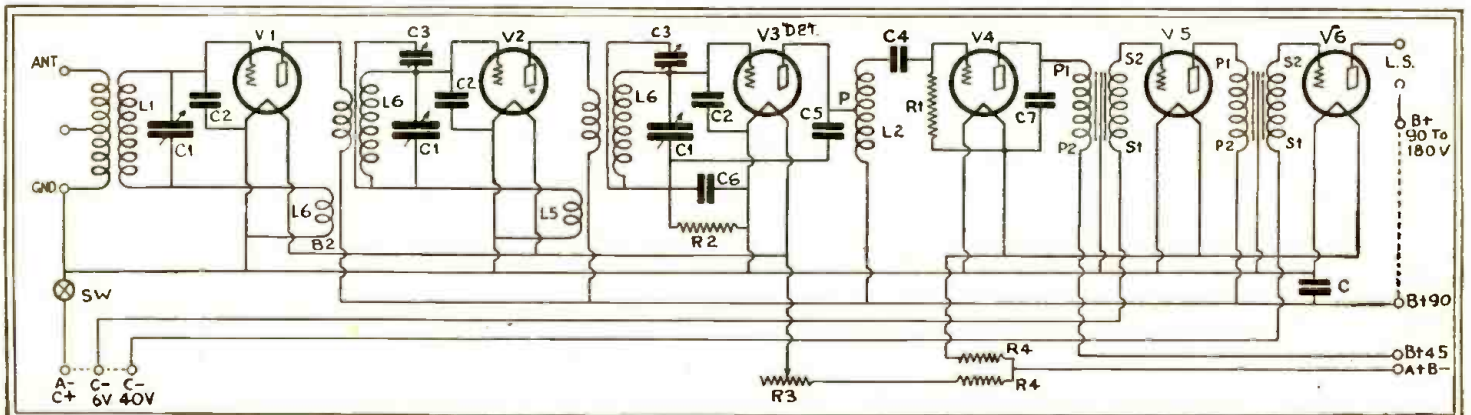

(Q. 42A) Schematic circuit of the Crosley "RFL-90" receiver mentioned by Mr. Garriott; note the system of neutralization.

All you need is a little TRAINING to make a SUCCESS in RADIO

"YOUNG MAN, study radio!" That's what every ambitious young man of today is told by J. H. Barron, Radio Inspector of the U. S. Department of Commerce. Radio is crying for trained men. Experienced radio operators and service men are in great demand. A very serious shortage exists. Practically all of the seven thousand licensed commercial operators are now employed and the need is constantly increasing. Radio needs thousands of trained men. Are you prepared to take advantage of this big opportunity? Ships at sea, planes in the air, broadcasting stations, manufacturing plants, as well as dealers, require thousands of experienced radio men.

You Can Easily Learn Radio at Home Through This Course Sponsored by the Radio Corporation of America

RCA sets the standards for the entire radio industry . . . And this RCA Radio Institutes' Home Laboratory Training Course gives you the *real inside secrets* of radio *quickly and easily!* In your spare time, you can obtain all the information you require to make a success in radio. You study at the very source of all the latest, up-to-the-minute developments. This is the only radio course sponsored by RCA, the world's largest radio organization. This is the *real way* to study radio. Learn radio under the direction of RCA . . . under the men who actually made radio what it is today!



Radio Mechanic and Inspector
\$1800 to \$4000 a Year.

Graduates Find It Easy To Secure Good-Pay Radio Jobs

You actually *train* for success. Every graduate of RCA Institutes has the ability and the confidence to hold a well-paid radio job. You learn radio by actual experience with the remarkable outlay of apparatus given to every student. Every radio problem, such as repairing, installing and servicing fine sets is covered in this course. Students of RCA Institutes get first-hand information and get it complete . . . That's why every graduate of RCA Institutes who desired a position has been able to get one. That's why they're always in big demand. No other radio school can make such a claim as this!



Broadcast Operators
\$1800 to \$4800 a Year

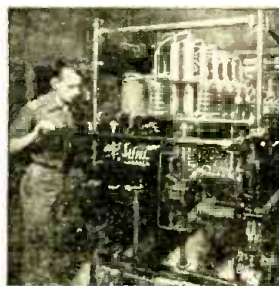

Broadcast Station Mechanic
\$1800 to \$3600 a Year.

Step Out Towards Success in Radio Today!

Get out of the low-pay rut. Make your first move towards a pleasant and profitable career in radio today by sending for this free book . . . "Radio . . . the Field of Unlimited Opportunity." Read these forty fascinating pages, packed with pictures and descriptions of the brilliant opportunities in radio. Learn all about the oldest and largest commercial radio training organization in the world. See how you, too, can speed up your earning capacity in the fastest-growing industry of today. Others have done it and so can you!



Land Station Operator
\$1800 to \$4000 a Year.

Others have done it and so can you!

For the added convenience of students who prefer a Resident Study Course, RCA Institutes, Inc., has established Resident Schools in the following cities:

- New York 326 Broadway
- Boston, Mass. 899 Boylston Street
- Philadelphia, Pa. 1211 Chestnut Street
- Baltimore, Md. 1215 N. Charles Street
- Newark, N.J. 560 Broad Street

Home Study graduates may also attend any one of our resident schools for post-graduate instruction at no extra charge.

Clip this Coupon NOW!

RCA INSTITUTES, INC.

Formerly
Radio Institute of America



RCA INSTITUTES, Inc.
Dept. RC 2, 326 Broadway
New York, N. Y.

Gentlemen: Please send me your FREE 40-page book which illustrates the brilliant opportunities in Radio and describes your laboratory-method of instruction at home!

Name.....
Address.....

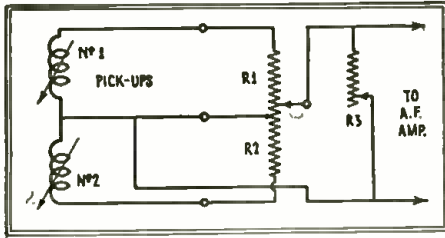

(Q. 45) Schematic arrangement of a "fader" assembly, for two phonograph pick-ups.

densers in all schematic circuits incorporating screen-grid tubes as well as the R.F. chokes often specified. The use of these is necessary to successful operation.

"C" BIAS FROM MAJESTIC "SUPER B" —HUM IN STEWART-WARNER

(44) Mr. Fred Hackett, Sioux City, Iowa.
(Q.) Please advise me as to whether a Majestic Super "B" eliminator can be wired to supply the "C" bias for a '71 power tube and also a 4½-volt bias. This eliminator supplies 60 milliamperes at 180 volts.

(A.) A 2000-ohm resistor, connected between the center tap of the power transformer and the negative terminal of the power unit, will supply the required bias for a '71 tube. If the resistor is equipped with a sliding contact, the bias may be varied and, if two contacts are provided, the 4½

volts required as the bias potential for '01A-type tubes may also be obtained.

When securing a bias voltage in this manner, the "C" voltage is obtained at the expense of the "B" voltage; and causes a corresponding reduction in the total "B" available.

(Q.) A Stewart-Warner receiver of the "Series 900" type has a strong hum background that cannot be eliminated by any of the ordinary service means—an unusual condition for this particular model radio set. There are no open or shorted bias resistors. Please suggest a remedy.

In addition to the usual causes of hum, such as a shorted or open grid resistor (R4 or R5) there is the possibility of one of the '27s being poor; the detector tube being most likely to cause this effect. Also, a reversed field coil in the dynamic reproducer may cause the same effect. A handy adapter for locating a reversed field coil is shown in schematic form in these columns. The plug fits into the receptacle on the chassis, and the plug of the dynamic reproducer fits into the adapter receptacle. Throwing switch "Sw3" to one position or the other will quickly indicate whether the brown-white and brown-green leads, going to the outer terminals mounted on the speaker shell, should be reversed.

This field-coil reversing unit may be used wherever the dynamic reproducer leads are similarly wired to a 4-prong plug.

ELECTRAD FADER—PLATE RESISTANCE—25- OR 60-CYCLES?

(45) Mr. Perry N. Daly, Malden, Mass.
(Q.) I have an Electrad "Super-Tonatrol," type 7. Please show this unit connected as a "fader"

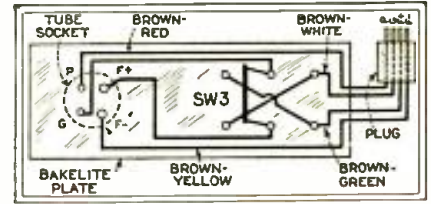

(Q. 44) A Service Man's adapter, to test polarity of dynamic-speaker field connections (see page 373)

for swinging from one pick-up or microphone to another.

(A.) The circuit for this and similar units is shown in these columns. The pick-ups are numbered 1 and 2. This fader controls volume on only one pick-up at a time.

In order to maintain a fixed volume limit, a separate control, in shunt with the output of the pick-ups, is recommended. This is preferably a 100,000-ohm unit, indicated as R3. It may be adjustable in small steps, or continuously variable. Each half of the fader is numbered, R1 and R2, and each has a resistance of 25,000 ohms.

(Q.) In the October issue of RADIO-CRAFT magazine is shown a table of tube characteristics. Is the plate resistance an A.C. or a D.C. value?

(A.) The values shown are the A.C. resistances of the tubes. For three-element tubes, this may be considered approximately the same for D.C. measurements. Four-element (screen-grid) tubes do not come within this class; their plate circuits' ohmic resistances are A.C. values, and are above the D.C. value.

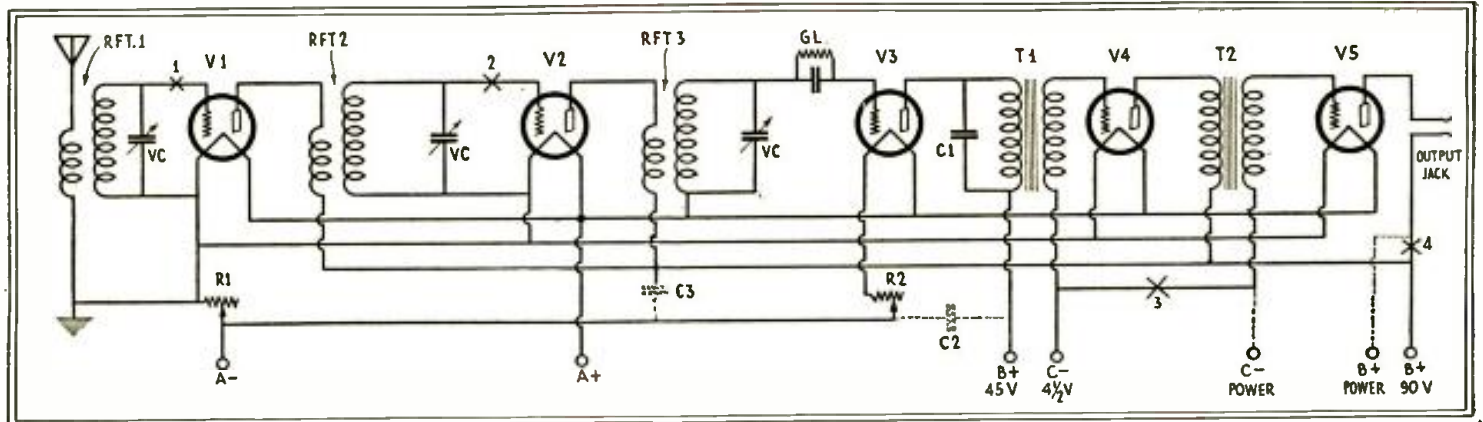

(Q. 43) Schematic circuit of a standard 5-tube radio set of early vintage. Improvements in this circuit design are described in the accompanying text and Xs indicate the points of alteration.

Letters from Radio Craftsmen

(Continued from page 393)

If S.W. fans will connect a 0-50,000-ohm variable resistor across the secondary of first audio, they will find it useful in cutting out regeneration squawks and an excellent volume control.

DON GRIFFIN,
117 East 22nd St.,
Kearney, Nebraska.

AN OLD-TIMER

Editor, RADIO-CRAFT:
Recently I received a few copies of RADIO-CRAFT. I am very well pleased with the make-up of your magazine; it is a step in the right direction, getting back to fundamentals of the game. I was pleased to get the copy with my old friend Jenkins' picture on the cover. I am a former Washingtonian. I may say radio has been my hobby since 1914.

In the mountains of Eastern Tennessee, our reception is very good, with distance. They know very little of the game down here. Manufacturers should give explicit instructions with schematic diagrams of their circuits; and less time would be required to set things in order again.

WM. J. REARDON,
Sup't., Electrotpe Div.
Kingsport Press,
Kingsport, Tenn.

GOOD DX IN CITY

Editor, RADIO-CRAFT:
I find Mr. E. M. Welling wants to know if any other fan has got any foreign DX on our broadcast band. To date I have verification of stations as follows:

- Austria, 1; China, 2; Cuba, 2; Czechoslovakia, 1; Denmark, 1; Germany, 11; Haiti, 1; Holland, 1; Porto Rico, 1; Spain, 2; Alaska, 1; Hungary, 1; Italy, 2; Japan, 1; Mexico, 2; Morocco, 1; New Zealand, 1; Norway, 1; Poland, 1; Sweden, 2; Switzerland, 1; Australia, 5.

All these stations were logged on a six-tuber which I built. I am using five '01A's and one '12A, with only 135 volts "B." My aerial is about 60 feet long. I have an ordinary ground, which is a cold-water pipe. I received these stations between 1:30 a.m. and 6 a.m., Central Time.

LARRY LUCAS,
1928 Canalport Ave.,
Chicago, Ill.

"THE ONLY THING"

Editor, RADIO-CRAFT:
I hope you keep up the good work, as short waves are the only thing for a real thrill. At present I am using a Silver-Marshall receiver and hear the following stations, from which I have verifications, with loud-speaker volume: PCJ, PIII, NR11, 2FC, VK2ME, GBS and G5SW. I have written to GBU, OHK2, DHC, XCR.

GEORGE C. STARR,
Box 473,
Derry, Pa.

WHAT XDA IS DOING

Editor, RADIO-CRAFT:
Station XDA is still experimental but, if successful will be used for transoceanic telephone service. It is located at Chapultepec, a suburb of Mexico City, and has 20 kilowatts in the antenna.

MERLE A. HEATH,
501 Oak Ave.,
Waterloo, Iowa.

SUMMER BETTER THAN WINTER?

Editor, RADIO-CRAFT:
The Mexican short-wave transmitter XDA heard by correspondents lately was testing with DIII, Nauen; all conversations were in the German language, which accounts for many listeners not understanding the call letters. The regular daylight wave is almost exactly 16 meters. They have a terrific signal here on this wave, and 32 meters, the one employed by them after 6 p.m., E. S. T. I have not heard them lately on voice. DIII was very good here.

This is the worst season of the year for reception of short-wave signals above 20 meters from Europe. Both 5SW and PCJ were at good loud-speaker strength here during the summer; but up till March they will be very poor except at rare intervals, as I have found from previous experience. Signals from 5SW reach maximum strength in this locality at about 3:30 p.m., and then begin to grow weaker as the evening advances; this usually holds good until about March. The Javanese station, PLF on

(Continued on page 415)

Radio's Greatest Bargains!

As Long As the Supply Lasts

Send for
FREE
RADIO
SET
CATALOG
A Postal
Card
Brings It.

THESE are the greatest radio set bargains that have ever been offered. The radio sets listed here are standard sets made by the greatest and best known radio set company in America.

All of these sets are battery sets; but this is only one reason why they are sold at such ridiculously low prices.

The other reason is that these sets are mostly demonstration and display models from New York's largest radio and department stores.

We have been able to make connections with a number of houses in New York City, and we secured these fine sets at remarkable prices. Due to these circumstances, we are enabled to sell them to you at only a fraction of their original cost.

Important!—Set Builders, Constructors and Experimenters

Even if you do not need any one of these fine sets, here is a tremendous opportunity to get parts at prices next to nothing. Everyone of these sets contains in addition to the valuable cabinet, a goodly quantity of radio parts, such as, condensers, transformers, sockets, tuning dials, coils, etc.

These sets contain from \$25.00 to \$50.00 worth of radio parts, if you had to buy them separately. In many cases, it will pay you to rip a set apart in order to get these valuable parts at unheard of prices. So, even if you do not need a set, the tremendous value in the separate parts will recompense you for the small outlay.

TURN THESE SETS INTO BIG MONEY!

There are still many families and many houses not equipped with radio today. At the prices at which we are selling them, it will pay you to install these sets and sell them at an excellent profit.

A number of our customers have made as much as \$20.00 and \$30.00 on each one of these sets by installing them, incidentally making a profit on tubes, loud speakers, etc.

Remember, we do not sell you these sets as brand new. They all have been used somewhat, but they are all in excellent condition, and, by going over the cabinets with some furniture polish, or otherwise renovating them, they will make a first class appearance and, in most instances, you will not be able to tell the set apart from a new one. This is your great opportunity to make a few extra dollars, and we trust that you will not let this opportunity go by.

We promise prompt shipments. We have a large supply of these sets on hand, and, in most cases, can ship within 24 to 48 hours.

ALL SETS ARE TESTED BY OUR EXPERTS AND WE GUARANTEE THEM TO WORK SATISFACTORILY.

Radiola 25 Superheterodyne

The Radiola 25, made by the General Electric Company, and sold by the Radio Corporation of America, is a genuine "Superheterodyne." This is a special circuit, the patents of which are jealously held by the R. C. A. and infringement is vigorously prosecuted, due to the value of the circuit. The particular adaptation used in this receiver is known as the "second harmonic" circuit. All the "intermediate frequency transformers" are contained in a nicked "catacomb." This catacomb alone cannot be bought for less than twelve dollars, and to have one of these installed in the 25 costs, usually, NOT LESS THAN EIGHTEEN DOLLARS. In addition, there are all the other parts, such as the tuning condensers, coils, loop aerial, etc.

The "25" is a loop-operated set. No outside aerial is needed, but an antenna may be used if desired, by running its lead-in close to the loop, or making a single loop in the lead-in and placing this loop in inductive relation to the loop on the "25."

A 2-mf. by-pass condenser is contained in the cabinet. A marked, color-coded cable is provided for battery connection. Sturdy 41-plate (brass) variable condensers ("straight line frequency" type) with pigtail rotor connections are used for loop and "oscillator" tuning. In Brooklyn, with this set we tuned in WLW, of Cincinnati, at noon, with WOR broadcasting on one side and WJZ on the other! This is physically impossible unless the receiver has "10-ke. selectivity."

Tuning of this receiver is accomplished through large "thumb-operated" tuning drums, so designed that stations may be "logged" directly on the drums. Two tip jacks are provided for testing filament potential. The small center knob controls a multiple-contact switch which changes the circuit to include one or two stages of A.F. amplification. Additional volume control is afforded by panel-mounted rheostats of the cartridge type. Two jacks for headphone use. Some constructors have stripped these receivers and reassembled the parts in an entirely different layout, resulting in a very compact, super-sensitive arrangement in portable form, the entire equipment being ideal for such design. The loop is 12 inches wide, 28 inches high and 5 inches across the top; and center-tapped.

A two-tone mahogany-veneer cabinet of original pattern houses the chassis and all batteries. Its overall dimensions are 28x19x12-inches high. The weight is 42 pounds. Six type 199 tubes are required.

EXACTLY as illustrated and described with cabinet and fine loop aerial. (No tubes, batteries or loud speaker.)

Shipped by freight or express collect List price of set \$265.00.



Price \$9.95

Radiola Portable (Second Harmonic) Superheterodyne [AR-812]

One of the most famous radio sets in America. Each cabinet is said to have cost twelve dollars to make. It is solid wood and finished in mahogany. This set may be placed on a table, the battery switch turned to "on," and music will be heard—without an outdoor antenna; it works with a loop aerial which is built inside the cabinet. The set is super-sensitive and, in certain localities, it is possible, on the east coast, to hear west coast stations. The cabinet holds all the batteries for the six "dry-cell" tubes required.

In locations near strong broadcast stations interference may be experienced. That is, a station may be heard several times. To overcome this, some experimenters have preferred to tune in the short-wave stations and then use their AR-812 as the INTERMEDIATE FREQUENCY AMPLIFIER of a superheterodyne hookup. This is accomplished by tuning the superheterodyne to a broadcast wave on which there is no interference. Then, short-wave signals are "heterodyned" from the short waves to the wavelength to which the super is tuned. In that way the tremendous amplification obtainable from this receiver is used to the fullest extent.

A few may wish to arrange the parts differently on another panel. In this receiver there are two large variable condensers of 31 plates each. The oscillator coils are honeycomb coils mounted on a hard rubber sheet. The main part of the set, the intermediate frequency transformers, are buried in beeswax in a shield can called the "catacomb." On the top of this can are mounted the tube sockets. A terminal strip is the terminus of



Price \$9.95

one end of a 6-wire cable for connecting the batteries. There are two porcelain base rheostats on the inside of the panel, controlled from the front; one has about 6 ohms and the other has about 20 ohms. A push-pull switch (center) turns the set on and off; another, (lower left) cuts in either one or two stages of A.F. amplification.

Although the cabinet is 37 inches long, 11½ deep and 11½ high, the panel of the receiver is only 19 inches long and 9 inches high. The difference lies in the two end compartments for "A" and "B" batteries. Six, type 1V199 tubes are required for this receiver. Dry-cell power tubes, the type "20," may be used in this set if a Naald or similar adapter is used. The weight of this set, without batteries is 36 pounds. Exactly as illus-

trated and described. Price includes cabinet but no batteries, tubes or loud speaker. Shipped by freight or express, collect. List price is \$220.00.

HOW TO ORDER

Remit amount by money order, cash or certified check (personal checks occasion delay). Order direct from this page at prices quoted. No C.O.D. orders on this sale accepted.

RADIO SPECIALTY CO.

BUY FROM RADIO'S OLDEST MAIL ORDER HOUSE

98C Park Place
New York City

Science Fiction Magazines

A SCIENTIFIC EDUCATION WHILE READING THE MOST MARVELOUS FICTION

Once you have read your first science fiction magazine, you will never let a month pass without making every effort to read the next issue. Hours of pleasant pastime are well spent in reading stories that you like—stories written by men who have spent many years in study of the science and have attained literary success—stories that are entertaining and educational as well. In the Science Fiction Group you will read stories of the H. G. Wells, Jules Verne and Arthur B. Reeve type, with a techni-scientific background.



In **SCIENCE WONDER STORIES** you will find creative ideas that reach beyond the world of human civilization, stories of interplanetary trips, transmutation of the elements, robots, fourth dimension and many other stories of scientific wonders.

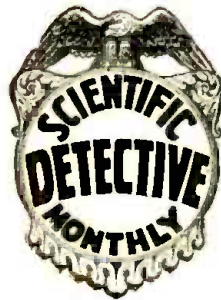

is the first national detective monthly with a scientific background and has as its Editorial Commissioner, Mr. Arthur B. Reeve, the foremost science detective fiction writer and author of the world-read "CRAIG KENNEDY" Series. In this issue of **SCIENTIFIC MONTHLY** you will read also "The Bishop Murder Case" by S. S. Van Dine. It contains a brand new Craig Kennedy story, and many other scientific detective stories written by such famous authors as Dr. David H. Keller, Captain S. P. Meeks, U.S.A., etc.



In **AIR WONDER STORIES** you will read stories that reach beyond present-day aviation methods—future warfare—gravity nullifiers—cities of the air—super bandits of the air, trips around the world, and all the gripping revelations to expect of aviation 100, 1,000 and 10,000 years hence.

Each magazine in the Science Fiction Group contains 100 pages and a four-color cover. Many full-page illustrations by the famous artist, Paul, and interesting scientific news and information make every issue worth reading and invaluable for your library.

This unusual offer of eight months of any one magazine for one dollar will last for a limited time only. Send in the coupon immediately!

25c *The Copy* **On All Newsstands** or write direct

MAIL
COUPON
→
NOW

STELLAR PUBLISHING CORP.,
98 Park Place,
New York, N. Y.

Enclosed find \$....., for which enter my subscription to

SCIENTIFIC DETECTIVE MONTHLY
 SCIENCE WONDER STORIES
 AIR WONDER STORIES

for eight months. Check which you prefer.
(Canada and foreign \$1.25.)

Name

Address

City..... State.....

R.C.-230

8 MONTHS
ANY ONE MAGAZINE
\$1.00
(Canada and foreign \$1.25)

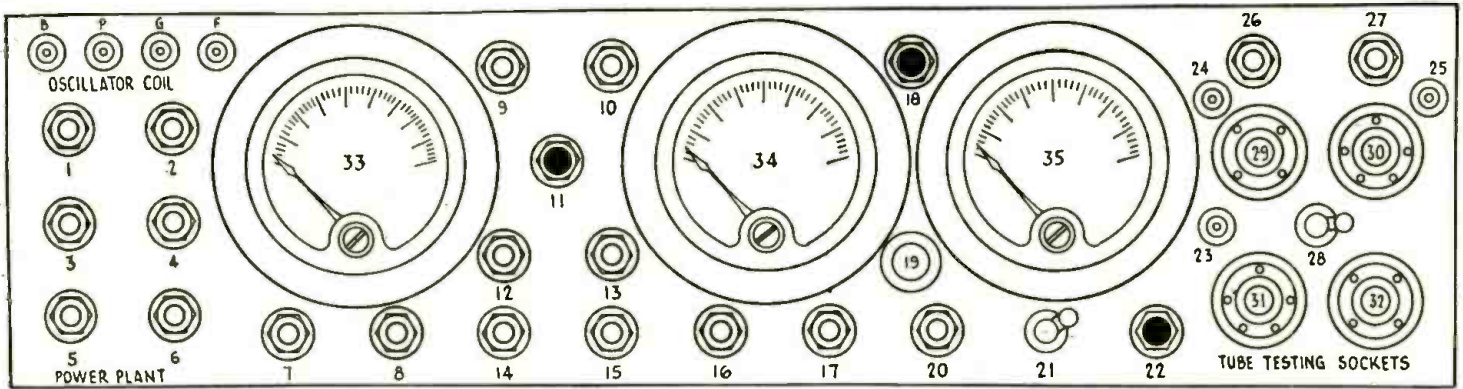

Fig. 1

Layout of panel of the "instrument tray." One pair of sockets test tubes directly, and the others permit use of the adapter plug.

Testing Equipment

(Continued from page 363)

screen-grid "+" bias, 100 scale; 14, plate, 100 scale; 15, grid, 100 scale; 16, D. C. fil., 10 scale; 17, A. C. fil., 4 scale; 18, spring-and-button switch to be pressed for 25 mil. scale; 19, pearl push-button marked "stop

oscillation"; 20, A. C. fil., 16 scale; 21, nicked snap-switch marked "Zero-Bias"; 22, spring-and-button switch to test S. G. tubes; 23, tip-jack marked "Screen-Grid";

24, 25, tip-jacks for overhead-filament tubes; 26, 5-volt rejuvenator; 27, 3-volt rejuvenator; 28, nicked snap-switch marked "UX—heater"; 29 and 30, UX and UY sockets, for

Fig. 3. Right A.K. "55" layout.

Fig. 2. Below Rear layout of Diagonometer.

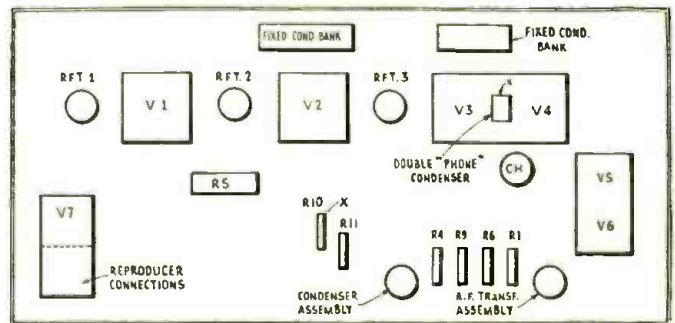
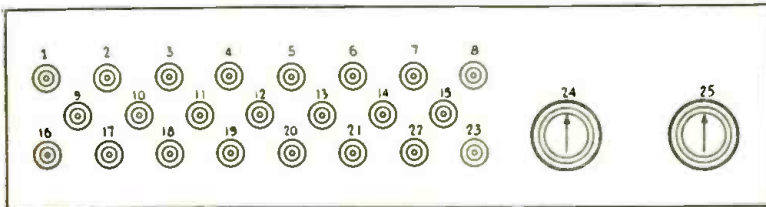

EVERY
SERVICE MAN
SHOULD OWN
THIS BOOK!

S. GERNSBACK'S RADIO ENCYCLOPEDIA

The First Real Radio Encyclopedia Ever Published

Regular Price \$2.00

Our Special Price \$1.49

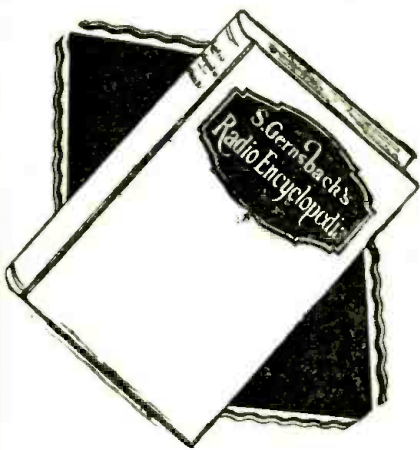

(1930 Definitions)
FULLY ILLUSTRATED
Size 9 x 12 in.
Over One Inch Thick
168 Pages
Written in Plain English

EDITED by SIDNEY GERNSBACK, Author of "Wireless Course in Twenty Lessons" — "One Thousand and One Formulas" — "Practical Electricity Course" — "The Radio Educator," etc.

S. GERNSBACK'S RADIO ENCYCLOPEDIA is the only standard work ever published in America attempting to classify alphabetically the countless words used in the highly specialized science of RADIO. The ENCYCLOPEDIA is written in plain English so that everybody can understand the definitions and descriptions.

No expense has been spared, covering over two years in compilation, to make it worthy a place in your library.

It is published in one volume—168 pages—size 9 x 12 inches, over an inch thick and nicely accommodates the beautiful illustrations and the large, easy-to-read type.

The work contains 1,930 definitions, 549 photographs, drawings and diagrams.

REMEMBER THIS IS A REAL ENCYCLOPEDIA — NOT A DICTIONARY — and very few of the things described and illustrated in this volume can be found in any diction-

ary, or any other encyclopedia.

The book contains as a supplement a classified cross index designed to bring together radio references under one heading having relations in common.

All circuits new and old are described by word and picture and every part and apparatus used in Radio is explained and made understandable by means of photographs and drawings.

The volume is printed upon fine paper—bound in full black Keratol, marbled paper fly leaves and end sheets, with the title stamped in gold.

SEND NO MONEY

Just Pay Postman

(Canada or Foreign send Check or Money Order for \$1.75)

ISKOR PRESS, Inc., R-230
286 Fifth Avenue,
New York, N. Y.

Send me one copy of Sidney Gernsback's First Radio Encyclopedia in one volume as advertised. I will pay postman \$1.49 plus postage on delivery.

Name

Address

Town and State

**44TH ST.
HOTEL**
Just East of B'way

*One of New York's
New Hotels at Right Prices*

A high-class hotel in the very center
of Times Square and within walking
distance of all Shops, Theatres, etc.

300 Rooms—300 Baths
\$2.50 & \$3.00 per Day

A Restaurant of Unusual Excellence
Special Weekly Rates

10 Tools in One

A SMALL but handy article which serves for every possible need of the all-round mechanic. Invaluable in any emergency.

An excellent combination of utilities for the household—every necessity featured: HAMMER — KNIFE-SHARPENER — NAIL-PULLER — BOTTLE-OPENER — SCREW-DRIVER — CORK-SCREW — CAN-OPENER — WEIGH-SCALE — RULER — TABLE OF WEIGHTS AND MEASURES

Just glance at the illustration and you will see how really useful this article is. The "Ten in One Tool" is 10 inches high and finely nickel-plated.

The new tool is not only handy in the household, but every TOURIST, AUTO-IST, CAMPER, PICKNICKER, BOY-SCOUT, FISHERMAN, CANOEIST, etc., should carry in his bag one of these indispensable combination tools. No SHOP, OFFICE, STORE, GARAGE, FARM, BOAT, should be without one. PRICE \$1.00, POSTAGE PAID.

Be the first one to own the "Ten Tools in One" in your own town.

Send your order today, pin a dollar bill to coupon below and the shipment will go forward to you the same day as received.

GREN PARK TOOL CO.
245 Greenwich Street
New York, N. Y.

Grenpark Tool Company, RC-230
245 Greenwich Street,
New York, N. Y.

Enclosed find \$1.00 for which please send me prepaid your "Ten Tools in One."

Name

Address

Town..... State.....

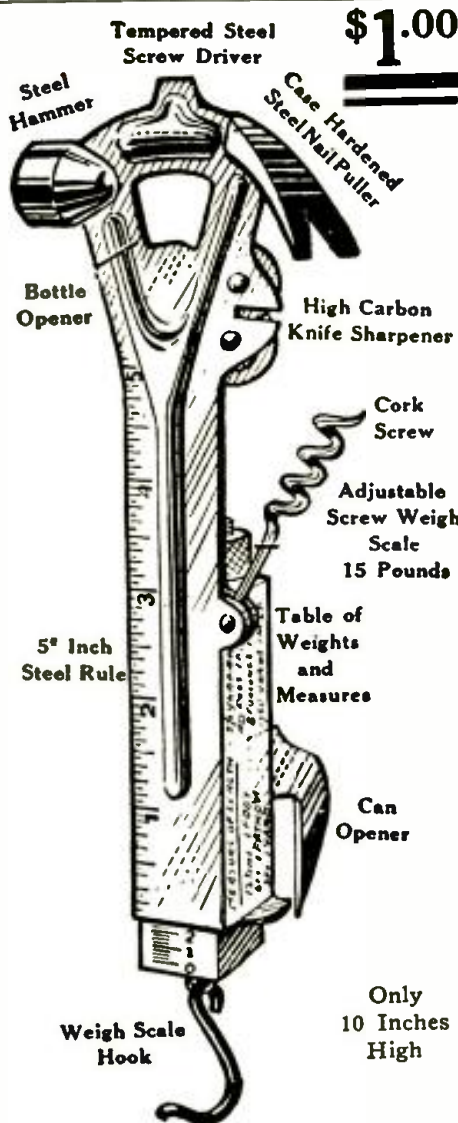

\$1.00

Only
10 Inches
High

Mail
Coupon
Send for Yours
TO-DAY

load tests; 31 and 32, UY and UX tube-testing sockets.

The meters are as follows: 33, A. C. Volts, scales 0-4-16-150-750; 34, D. C. Ammeter and Milliammeter, scales 0-25-125 Ma. and 0-2.5 Amps.; 35, D. C. Voltmeter, 1,000 ohms-per-volt, 0-10-100-250-750 Volts. Meter 33 is a Weston type 476; meters 34 and 35 are Weston instruments, type 301.

Operating Conveniences

A feature of great convenience to the service man is the *tube rejuvenator* which forms an integral part of this service instrument. If a tube test discloses the fact that any "thoriated-filament" tube is paralyzed, the tube may be rejuvenated promptly. In fact, it is possible to rejuvenate a number of tubes simultaneously without removing them from the set, by the use of the "analyzer plug" in conjunction with the "D. C. Fil" switch.

This "laboratory" does not require batteries when used as a "continuity tester."

The power plant of the Diagonometer is utilized to supply filament and plate A. C. potentials to an '81 or similar type tube, placed in one of the tube testing sockets. Two insulated-handle test leads are plugged into certain designated pin jacks (ordinarily used for the two plate leads of the oscillator coil). The milliammeter, being in the plate circuits, indicates the continuity of the circuit of which the two test leads are a part.

For reasons at once apparent to the practical service man, it is important that the various meters should be instantly available for external use. For this purpose, *pin jacks* are provided at the rear of the "instrument tray," so that any reading may be made on any meter through external connections. A 500,000-ohm resistor and a 30-ohm rheostat, mounted within the "tray", can also be connected in any external circuit by means of pin jacks provided at the rear of the tray.

On the rear of the case are mounted 23 tip-jacks. By connections to these it is possible to use any of the test instruments in the unit. A list of these posts and their markings are included herewith. The posts are identified in a pictorial plan (Fig. 2) by reference to the following arbitrary numbers:

1, milliammeter, 25-125 mil. scale; 3, 2 1/2-amp.; 2, between them, is the "+" terminal; 4 and 5, 500,000-ohms; 6, "G"; 7, "P"; 8, "B"—these three for audio transformer; 9, "+" D. C.; 10, 80 ohms, thermocouple; 11, third winding; 12, "750 V., A. C."; 13, "+ — A. C."; 16, "10 D. C."; 17, "750-250-100 D. C."; 18, .001-mf.; 19, .002-mf.; 20, "Neg. Com."; 21, 1-mf.; 22, (marked "9") 30-ohm; 24, knob of 30-ohm rheostat; 25, knob of 500,000-ohm variable resistor. Jacks 23, 14, and 15 (indicated as "10", "11", and "12" respectively) serve to make connections instead of operating panel switches.

Connections between the rear of the tray and the pin jacks on the panel are made by means of flexible leads, soldered to the jacks at the back of the panel.

Interior of Diagonometer

The exterior appearance is attractive; the inside of this instrument will bear equally critical inspection. Wiring is the cabled "switchboard" type. The lower part of the unit is wired separately from the removable

top panel; then these are joined by a cabled lead between the terminal strips numbered 16 in Fig. E.

Many of the other units that comprise the "tray" are discernable, as follows

- (1) 1-mf. condenser;
- (2) 500,000-ohm variable resistor;
- (3) analyzer-plug cable;
- (4) 30-ohm rheostat;
- (5, 6, 7, 11, 12, 13, 14) Multiplier resistors for voltmeters;
- (8) fixed condensers, .001- and .002-mf.;
- (9) fixed condenser, used in oscillating circuit, .0005-mf.;
- (10) audio transformer; this includes an extra winding for use with the thermo-couple meter.
- (15) overload relay to protect milliammeter;
- (16) terminals for tray wiring, and panel wiring;
- (17) step-down transformer for supplying filament voltages and rejuvenator voltages;
- (18) A. C. voltmeter;
- (19) milliammeter;
- (20) D. C. voltmeter;
- (21) pin jacks into which the oscillator coil is plugged;
- (22) three of the six jack-type switches, from which filament voltages are chosen when tubes are tested from the A. C. line;
- (23) jack-type switch for rejuvenator;
- (24) toggle switch;
- (25) pin jacks giving access to all meters and other included apparatus.

New Test Panel

A special panel is now obtainable which converts the instrument assembly from a portable device into a "permanent" installation at the service man's own test bench.

To make the change, it is merely necessary for the service man to lift the instrument tray from the carrying case and set it up on wrought-iron brackets fastened to the rear of the test panel, of which the meters in the instrument tray then appear to form a part.

A plug receptacle at one end of the test panel is provided for the special lamp cord of the equipment. The current to this outlet is controlled by a toggle switch, directly below it.

The equipment may be used for measuring the capacity of condensers of between .01-mf. to 9 mfs. Open transformers can be bridged, condensers can be tested for breakdowns and leakage, tests can be made of condenser and choke-coil outputs and capacity outputs on sets not wired for such a purpose. A great many other combinations and tests are possible, meeting every need that may be encountered in practical servicing of radio receivers.

Actual Set Analysis

To illustrate the ease with which the Diagonometer will locate trouble in any radio receiver, the writer performed a test on a set of the popular Atwater Kent Model 55, which had been returned to the dealer because of faulty performance.

The circuit of the Model 55 incorporates two stages of tuned R. F. amplification using A. C. screen-grid tubes, a '27 type detector tube, one stage of resistance-coupled audio using a '27 and a final audio stage utilizing '45-type tubes in push-pull. The rectifier is an '80-type, full-wave.

"ELECTRICAL OPPORTUNITIES"



A full knowledge of electricity, as taught in the New York Electrical School, makes you independent, gives you your choice of either a BIG PAY job with one of the world-famous electrical companies, or a business of your own. ELECTRICITY is also a stepping-stone to Aviation, Automobile Engineering and other highly paid professions.

Here at the New York Electrical School you learn, not by correspondence, but by ACTUAL PRACTICE on full-size standard equipment. NO BOOKS used. Individual instruction—you can start any day. This School owns and occupies two seven-story buildings in New York—the city of most opportunities. It is widely known as the country's oldest and foremost institution for trade training. That's why big companies eagerly demand our graduates.

THE NEW YORK ELECTRICAL SCHOOL
21 West 17th Street, New York



FREE

This big 64-page booklet gives full information about the New York Electrical School courses and pictures of the equipment available for your personal use. Send for it TODAY. It's free.

MAIL TODAY

The New York Electrical School
21 West 17th Street, New York

Please send me FREE your 64-page booklet. It is understood that this request puts me under no obligation.

Name

Address

Editor, SLOGAN CONTEST,
RADIO-CRAFT,
96-98 Park Place, New York City.

SEE PAGE 392
2-2-30

Gentlemen:

I have written below my entry in your \$100.00 Prize Slogan Contest.

Name

Occupation..... Age.....

Street Address

City..... State.....

HOTEL CENTURY



111 West 46th Street

Just East of Broadway

JUST COMPLETED

N. Y. City

350 ROOMS — 350 BATHS

This New Hotel contains every modern appointment

Every Room has Private Bath

\$3.00 per day up, Single

\$4.00 per day up, Double

Situated in the heart of the city; near Railway Terminals. All Leading Shops and Theatres within a stone's throw.

JAMES A. FLOOD, Resident Manager

CLASSIFIED ADVERTISEMENTS

Advertisements in this section are inserted at the cost of ten cents per word for each insertion—name and address each count as one word. Cash should accompany all classified advertisements unless placed by a recognized advertising agency. No less than ten words are accepted. Advertising for the March 1930 issue, should be received not later than January 9th.

AGENTS WANTED

FREE BOOK. Start little mail order business. Hadwil, 27A-74 Cortlandt Street, New York.

BUSINESS OPPORTUNITY

CAPITAL—An experienced dependable broker will aid in financing projects of merit. Amster Leonard, East Orange, N. J.

SELL BY MAIL. Books, Novelties, Bargains! Large profits. Particulars FREE! D. Ellico, 521 South Dearborn, Chicago.

CHEMICALS

BOOKLET OF EXPERIMENTS and chemical catalog, 15c. General Chemical Company, Box 397, Reading, Penna.

DETECTIVES

DETECTIVES Earn Big Money. Excellent opportunity. Experience unnecessary. Particulars Free. Write, George Wagner, 2190B Broadway, N. Y.

INSTRUCTION

CATCH from 45 to 50 foxes from 4 to 5 weeks' time. Can teach any reader of this magazine how to get them. Write for particulars. W. A. Hadley, Stanstead, Que.

BE THE LICENSED RADIO DOCTOR of your community. Earn \$7.00-\$10.00 spare time evenings. Write now for free booklet, "Why the Radio Doctor?" Dept. C, 131 Essex Street, Salem, Massachusetts.

LEARN TATTOOING. Instruction catalog, dime. Miller, N431 Main, Norfolk, Virginia.

MOTION PICTURES

MOVIE FILMS. Standard Gauge, 250 feet Western or Comedy, \$1.00 Postpaid. Home Movies, Dept. R, Box 744, Minneapolis, Minn.

OLD MONEY WANTED

\$5 to \$500 EACH paid for Old Coins. Keep ALL old money. Many VERY valuable. Get Posted. Send 10c. for illustrated Coin Value Book, 4x6. Guaranteed Prices. We buy and sell. COIN EXCHANGE, Room 10. Le Roy, N. Y.

PATENT ATTORNEY

PATENTS — Time counts in applying for patents. Don't risk delay in protecting your ideas. Send sketch of model for instructions or write for free book, "How to Obtain a Patent" and "Record of Invention" form. No charge for information on how to proceed. Communications strictly confidential. Prompt, careful, efficient service. Clarence A. O'Brien, Registered Patent Attorney, 343-A Security Bank Building (directly across street from Patent Office), Washington, D. C.

PRINTING

1,000 BUSINESS CARDS \$2.75 postpaid. Samples free. John Miller, Montgomery, Ave., Narberth, Pa.

As a matter of record and reference it may be stated that one of the "Radio Service Data Sheets" (October, 1929 issue of RADIO-CRAFT, page 158) contains the schematic circuit of this receiver.

In preparing to locate the trouble, the receiver was connected up under actual working conditions. It was found to be selective and free from hum; but distortion was present to a considerable extent.

In following the standard routine, the tubes were tested first of all. The results are shown in Table No. 1. The Diagonometer was able to test the screen-grid A. C. tubes, the '27's and the '45's with equal facility and accuracy. A comparison of the readings with the "normal" table in the Manual supplied with the checker, showed that all the tubes were O.K. with the exception of one of the '45's. This tube was sub-normal, and hence was replaced with a normal tube which matched the other '45. Some improvement in tone quality was noticed.

The "universal-analyzer plug" was next brought into action. "No load" and "load" filament voltages were measured first and found to be correct. (Table No. 2).

Table No. 3 shows plate voltages, grid voltages and screen-grid voltages. All readings were normal with three exceptions. The detector plate voltage was much too low; the detector grid voltage was too high and the grid voltage on the last audio stage was about twice as high as it should be.

The unusual detector voltages indicated trouble at the small "phone" condensers bypassing the detector plate R. F. choke. A separate test of these condensers immediately disclosed the fact that one of these condensers was short-circuited. As soon as a new condenser was put in, the detector plate and grid voltages became normal.

The high grid voltage on the push-pull stage indicated too much grid-bias resistance. Since there are two bias resistors in parallel in this circuit, each was tested separately by a continuity test and the No. 1 (maroon) bias resistor was found open. When this was repaired the grid-voltage reading became normal. Before fixing this open circuit a distortion test indicated very clearly that over-biasing was causing trouble.

After the fault was corrected, the distortion test was again performed. This time the needle remained quite steady, regardless of signal fluctuations; except on very high volume, when there was a tendency for the needle to deflect downward, indicating slight underbiasing. (The faulty units are shown at "X" in Fig. 3.)

Having made the two repairs indicated, the set was again tried out under working conditions and was now found to operate perfectly. There was a complete absence of distortion and the tone quality was everything that could be desired. As a further precaution, however, the synchronization of the three tuning condensers was tested, using the thermo-couple. Synchronization was found perfect.

In finishing up the analysis, a "dial-calibration chart" was plotted, using the modulated radiator of the Diagonometer to set up the R. F. signals for this test.

The routine of the above analysis has been described, merely to give an idea of the ease with which these tests can be conducted, on any type of radio set.

TO NEW READERS

A few copies of the July, August, September, October, November, December and January issues of

RADIO-CRAFT

can still be had at the regular price of 25c each. Send stamps, cash or money order to:
RADIO-CRAFT 98 Park Place, New York

Table No. 1—Tube Tests

Type	Pos. in Circuit	Zero	Bias
Tube	Circuit	On Stop	On Stop
224	1st R.F.	22½	17½
224	2nd R.F.	24	17
227	Detector	25	17½
227	1st Audio	27½	20
245	2nd Audio	50	37½
245	2nd Audio	37½	28
280	Rectifier	1st PI 100	—
		2nd PI 87½	—

Table No. 2—Filament Voltage Readings

Type	Pos. in Circuit	No Load	Load
224	1st R.F.	2.5	2
224	2nd R.F.	2.5	2
227	Detector	2.5	2
227	1st Audio	2.5	2
245	2nd Audio	2.4	1.9
245	2nd Audio	2.4	1.9
280	Rectifier	5.0	4.2

Table No. 3—Plate, Grid Voltages

Type	Pos. in Ct.	No Load	Load
224	1st R.F.	150	150
224	2nd R.F.	150	150
227	Detector	120	36
227	1st Audio	160	60
245	2nd Audio	360	230
245	2nd Audio	360	230

Type	Pos. in Ct.	Grid Voltage	Screen Volt.
224	1st R.F.	2	85
224	2nd R.F.	2	85
227	Detector	20	
227	1st Audio	2	
245	2nd Audio	85	
245	2nd Audio	85	

Model 400-B Diagnetometer Used
Line Voltage—115 Volts

Interference Cures

(Continued from page 367)

to work around or touch any part of high-tension power system, or traction lines, even though interference trouble is suspected at these points. The very first reason is that the slightest carelessness on any one's part may result in loss of life; for some power lines carry hundreds of thousands of volts and are extremely dangerous.

It is to be remembered that transmission and traction lines of this kind are private property; and persons not officially connected with the companies operating them are not permitted to tamper with or repair defective apparatus. Power and traction companies are always willing to cooperate with outside interests in running down the sources of trouble and effecting the necessary repairs. When radio reception is interrupted by some defect in power or traction systems, a complaint should be presented to the proper officials, who are always glad to know of such defects as they often mean a loss of power (and therefore money) to the company.

(In the next issue of RADIO-CRAFT, Mr. Bristow will continue his discussion of the methods of detecting radio interference caused by defective apparatus and leaky lines. In many communities, radio clubs have been formed to deal with such conditions; and employ Service Men to do detective work on them.—Editor.)

EXTRA MONEY

IN YOUR SPARE TIME SELLING
Ex Libris — Beautiful Bookplates



Here is an opportunity for everyone, regardless of whether or not you have selling ability. You can make extra dollars in your spare time. Ex Libris (Beautiful Bookplates) sell rapidly and in large quantities—members of the family, friends and relatives will buy these bookplates without hesitating.

These artistic Duo-Tone Bookplates, illustrating old woodcuts and engravings are reproduced on antique-tint vellum paper, with name imprinted. They insure the owner against loss of cherished volumes and show the pride taken in a personal library.

Ex Libris (Beautiful Bookplates) sell at \$2 up per hundred with name imprinted. Write for our special profit plan of selling—or send 10c. for specimen and illustrated catalog of our unique series.

ISKOR PRESS, INC.

Dept. 9

286 Fifth Ave New York, N. Y.

SCIENCE FICTION CLASSICS

may now be had for home,
library, club or hotel

THOUSANDS of science fiction fans who have always desired to build a library of science fiction, may now do so because of an unusual means of publishing that we have been able to work out.

We are gathering a number of Science Fiction Classics, including the best works of the foremost writers, of which

"BETWEEN WORLDS" by Garret Smith

is the first of the series. Printed on durable paper, with stiff covers, size 6 x 9 inches, running 80 to 100 pages, these Classics deserve a place on your shelves—between the choicest books of your library.

The stories which we will publish are now out of print, and can be obtained only through our Science Fiction Classic Series.

"Between Worlds," the first of the series, is a most marvelous interplanetary story. All the complexities, fascination and the strangeness of the civilization of another planet are revealed to us in Mr. Smith's most vivid manner.

Each of these books will be on sale only a short time, and, therefore, if you wish to start your series, you must not miss this opportunity.

A new book will be published from time to time and, therefore, you will within a short time have accumulated a most desirable and valuable library of the best in science fiction.

50c The Copy

These books can only be had from the publishers.

STELLAR PUBLISHING CORPORATION

98R Park Place

New York, N. Y.

SONG WRITERS!



Substantial Advance Royalties are paid on work found acceptable for publication. Anyone wishing to write either the words or music for songs may submit work for free examination and advice. Past experience unnecessary. New demand created by "Talking Pictures", fully described in our free book. Write for it Today—Newcomer Associates 751 Earle Building, New York, N. Y.

When it comes to making sick radios well, or good radios better just

Remember there's a **CLAROSTAT** for Every Purpose

For literature, write CLAROSTAT Mfg. Co. 295 N. 6th St., Brooklyn, N. Y.

ALUMINUM BOX SHIELDS

Beautiful silver dip finish, 5"x9"x6"—\$1.89. We make any size to order in 24 hours.

All types of adapters. Full stock of Weston, Jewell and Readrite meters. Largest stock of Hammarlund, Amertran, Pilot, Carter and Yaxley parts. Octo-Coils and forms. Tube and coil shields.

Genuine Baldwin Type "C" phones, a necessity for short-wave reception, \$3.65 a pair. Brach TEST-O-LITE fits your vest pocket, \$1.50—postage prepaid.

BLAN THE RADIO MAN, Inc.

Est. 1923

89E CORTLANDT ST.

NEW YORK

PATENTS TRADE-MARKS

DON'T LOSE YOUR RIGHTS TO PATENT PROTECTION

Before disclosing your invention to anyone send for blank form "EVIDENCE OF CONCEPTION" to be signed and witnessed.

LANCASTER & ALLWINE
(Registered Patent Attorneys)
475 Ouray Bldg., Washington, D. C.
Originators of forms "Evidence of Conception"

SKINDERVIKEN Transmitter Units

95¢



Two for \$1.75

have hundreds of uses. Every amateur should have two or three of these amplifiers in his laboratory

A FEW USES FOR THESE UNITS

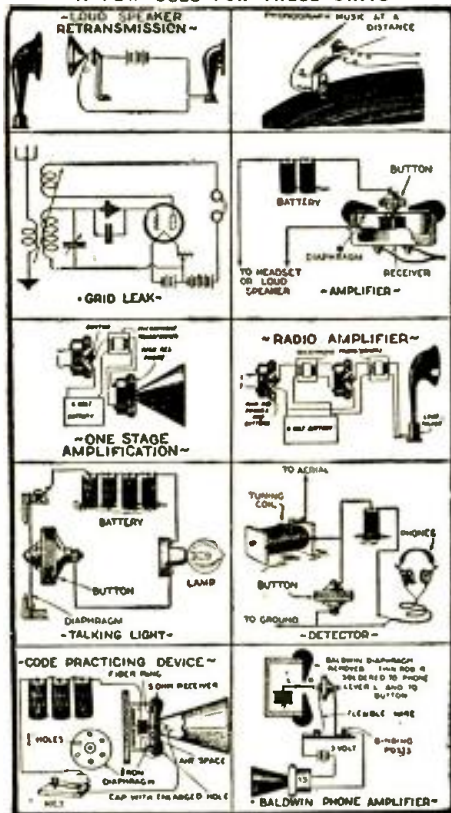

12-PAGE INSTRUCTION BOOKLET containing suggestions and diagrams for innumerable uses, furnished with each unit.

WE PAY \$5.00 IN CASH

for every new use developed for this unit and accepted and published by us.

P. G. Microphone Transformer



A Modulation Transformer specially designed for use with the Skinderviken Transmitter Unit. Has many other uses. Primary resistance, 1/2 ohm; secondary, 55 ohms.

\$2

FOR SALE AT LEADING DEALERS Or Order Direct, Using Coupon Below

SEND NO MONEY

When the postman delivers your order you pay him for whatever you have ordered, plus a few cents postage.

PRESS GUILD, Inc., 16-18 East 30th St., New York, N. Y. R-2-30 Please mail me at once as many of the following items as I have indicated.

....Skinderviken Transmitter Units at 95c. for 1; \$1.75 for 2; \$2.50 for 3; \$3.20 for 4.

....P. G. Microphone Transformers at \$2. When delivered I will pay the postman the cost of the items specified plus postage.

Name
Address
City..... State.....

Hammarlund Short-Wave Adapter-Receiver

(Continued from page 387)

which enables even approach to the critical state of the tube, where the maximum sensitivity condition exists. A nidget variable condenser (C1) having a capacity of .0001-mf. is used to control this feed-back.

The by-pass condensers C3, C4 and C5 are of 0.1-mf. capacity each. The R. F. choke L4 has an inductance of 250 millihenries. The design of this component is very important; its distributed capacity must be at minimum, since the frequency range is great and the choke is usually operated below its resonant frequency. That



A set of the plug-in coils used in the adapter-receiver, with their standard interchangeable mountings. The space-wound wires are supported on an insulating film.

is, it is operating at a frequency where the the only R. F. current that goes through passes through the distributed capacity.

Also, when the choke is used in a regenerative circuit, as it is here the inductance of the choke must be high. Otherwise, the output of the circuit will be shorted at some frequency and thus prevent the circuit from oscillating at that frequency. The specified choke fully complies with these requirements; having the necessary inductance, unusually low distributed capacity (only 2 mmf.) and a direct-current resistance of 420 ohms.

Battery Operation Required

The question, why shielding is not employed, undoubtedly comes to the mind of many. It has been avoided because of the mechanical difficulty in changing from one coil to another. The layout has been so arranged, however, as to minimize the capacitance between the grid and the plate wires. That is why the layout should be followed so carefully.

The receiver has been designed for battery operation because of its quiet and unflinching action. It is not desirable to use alternating current; both because of the noises introduced and because the tuning becomes very erratic.

The set, however, can be used with alternating-current receivers, batteries being used for the adapter. To do this, it is necessary only to disconnect the plate lead from the power unit, the battery's "B+" supplanting it. The minus post of this battery is connected to the minus of the power unit. The "A" supply is, of course, also separate; the plus and minus being connected in the standard way.

Either a '12A or a '01A tube may be used in the detector circuit. The '12A is more sensitive, having a lower plate impedance, and is also a more stable oscillator. Although the '00A is more sensitive than either, it is too noisy. A '99 tube may be used; but the regeneration is poor at the lower wave-lengths.

Operation

While the tuning of this receiver requires exactness, it is not difficult. The drum dial (knob control) with its 5-to-1 reduction ratio permits this necessary precision adjustment.

The regeneration condenser is an important tuning factor. When tuning, it should be turned until a hissing sound is heard; this is an indication that the detector tube is just beginning to oscillate. This condition should be maintained throughout the tuning. The station can then be tuned in by the larger condenser. The volume is, of course, controlled by R.

The oscillating state of the detector tube can be learned by touching the stator plates of the tuning condenser. A sharp click will be heard if the circuit is oscillating.

The value of the grid leak varies from 2 to 9 megohms; although best results are usually obtained with a 5-megohm value.

Wiring and Layout

As stated, the receiver is an unusually sensitive one, capable of consistently picking up stations across the seas. But (and a big BUT, too), the wiring must be done carefully and the layout must be followed religiously. Carelessness in either, or both, will impair the results seriously.

Fig. 1

The schematic circuit of the Hammarlund short-wave adapter-receiver, which may be coupled to any standard audio channel; although, as shown here, the specific design is intended to utilize a broadcast receiver's amplifying stages. It may be used with an A.C. set, but should be operated by battery power to obtain hum-free reproduction. A condenser between the aerial post and lead-in may greatly improve reception; experiment should be made to determine the best value, probably below .0001-mf.

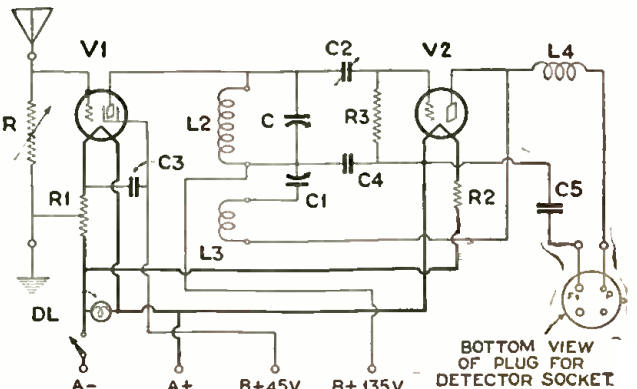

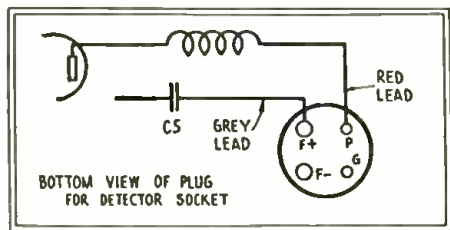

Detail of the plug used to connect the adapter-receiver to the amplifier of a broadcast set, by Fahnestock clips to C5 and the plate choke LA.

It is imperative that all leads be as short as possible, as well as direct. All wires carrying radio-frequency currents should cross each other, if at all, at right angles and clear each other as much as possible. The lead length may be increased slightly to permit this.

All connections should be soldered wherever possible. Care should be exercised here not to use too much flux for this causes leakage.

Any type of audio amplification may be added. It is only necessary to connect the plate and the "B+" leads of the amplifier to the same respective posts in the detector tube output circuit of the adapter.

Be sure that the filaments are so connected that a switch will turn them all off at the same time; e. g., the audio as well as the R. F. and the detector.

(The author of this article will be only too glad to answer any queries as to this receiver or its components.

List of Parts

- C—One Hammarlund .00014-mf. variable condenser, type MI-7;
- C1—One Hammarlund .0001-mf. midget variable condenser, type MC-23;
- C2—One Hammarlund equalizing condenser, type EC-80;
- C3, C4, C5—Three Sprague 0.1 mf. fixed condensers, type F;
- L2, L3—One set of Hammarlund short-wave coils, type SWC-3, and one special short-wave coil, type SWT-120;
- L4—One Hammarlund radio-frequency choke coil, type RFC 250;
- R—One Electrad Tonatrol, type P;
- R1—One Yaxley 20-ohm mid-tapped fixed resistor, type No. 820C;
- R2—One Yaxley 4-ohm fixed resistor, type No. 804;
- R3—One Durham metallized grid leak, (see above);
- One—Yaxley midget battery switch, type 10;
- One Hammarlund knob-control drum dial, with light, type SDW;
- One Hammarlund adapter plug and cable, type SWAP;
- Three Hammarlund walnut knobs, type SDWK;
- Two Eby sockets, type No. 12;
- One Westinghouse micarta panel, 7 by 14 inches;
- One baseboard, 9 by 13 by 3/4-inch;
- Small hardware.

CLEAR RECEPTION AT HIGH ALTITUDES

IS there a vertical "skip" distance? From a recent Associated Press dispatch it is learned that pilots report reception of the signals of the ground radio operator more clear at 12,000 feet than at 100 feet.

Sound Projection

(Continued from page 379)

them. Some are hooked up in series, which means that each cell must be watched so that it will maintain a constant charge with the rest; for one dead cell would mean putting several batteries out of the working.

"B" and "C" batteries, rather than rectified alternating current, also will be found in many of the installations; and of course these have to be tested regularly and replaced at the slightest signs of defect or wear.

There are lenses and reflectors to clean and polish and reset; parabolic reflectors and huge condensers, in many cases, need as much attention as the projection lenses themselves.

There are "exciting lamps" that must be cleaned or replaced if they show the slightest signs of wear; and the photoelectric cell must be spotless and handled with the utmost care.

The machines have to be oiled; not bathed in oil, but given just the correct amount at regular intervals. The picture film must be inspected to see that there are no points of weakness or poor patches that will open up in the machine.

Some of the devices are provided with motor-generators instead of storage batteries, to power the amplifier tube filaments and exciter lamps, and these too must be given their share of attention; not forgetting the bigger motor-generators that supply the high-ampere direct current for the arc lights.

All of these, and a thousand and one additional details, go to make up the necessary routine of the projection room. The average visitor sees a reel put in the machine and a record placed, and perhaps a "change-over," and thinks it is all very easy and that the projectionists "get away with murder." The part that seems the most mysterious to them usually is "How do you know when to change over?" Of course, a perfect change-over is not the easiest thing for a novice, but, if that were the hardest thing a projectionist had to worry about, he most certainly would be "getting away with murder."

The "Sound" Service Man

Supplementing all these attentions given the equipment by the regular projectionists, a Service Man (usually employed by the manufacturers of the sound equipment) comes around at regular intervals and makes a thorough inspection of the equipment.

He carries instruments, with which he can tell the exact condition of the tubes in the amplifier and the various circuits; so that he may forestall any trouble that might be developing. He has a printed report form, which he is required to fill out for every visit he makes. This report is filed with all the history of that installation, so that reference may be made to it at any time to facilitate emergency service, etc.

Some of the questions that appear on the average report sheet are as follows: Name of subjects being run and their producers? Sound on film or disc? Quality of sound in theater, and remarks on same? Average low point? Readings of various meters?

"Here at last is THE BOOK that we of the Radio profession have needed for a long time. It is the best and most complete handbook ever published," says J. H. Bloomenthal, Chief Radio Operator, U. S. S. B. Steamship "East Side."

THE RADIO-MANUAL

A New Edition

Complete new chapters on aircraft radio equipment; Practical Television and Radiomovies with instructions for building a complete outfit; radio interference; 100% modulation; latest equipment of the Western Electric Co.; the Marconi Auto-Alarm System; and many other developments of the past year. All this information is added in the new edition and, besides, the entire book has been brought right up to date with much new material. The Radio Manual continues to be the one complete and up-to-the-minute handbook covering the entire radio field.

A Handbook for Students Amateurs Operators Inspectors



20 big chapters cover: Elementary Electricity and Magnetism; Motors and Generators; Storage Batteries and Charging Circuits; The Vacuum Tube; Circuits Employed in Vacuum

Tube Transmitters; Modulating Systems and 100% Modulation; Wave-meters; Piezo-Electric Oscillators; Wave Traps; Marine Vacuum Tube Transmitters; Radio Broadcasting Equipment; Arc Transmitters; Spark Transmitters; Commercial Radio Receivers; Marconi Auto-Alarm; Radio Beacons and Direction Finders; Aircraft Radio Equipment; Practical Television and Radiomovies; Eliminating Radio Interference; Radio Laws and Regulations; Handling and Abstracting Traffic.

An immense amount of information never before available, including detailed descriptions of standard equipment is presented.

Prepared by Official Examining Officer

The author, G. E. Sterling, is Radio Inspector and Examining Officer, Radio Division, U. S. Dept. of Commerce. The book has been edited in detail by Robert S. Kruse, for five years Technical Editor of QST, the Magazine of the American Radio Relay League. Many other experts assisted them.

Free Examination

The new edition of "The Radio Manual" has just been published. Nearly 900 pages, 369 illustrations. Bound in Flexible Fabrikoid. The coupon brings the volume for free examination. If you do not agree that it is the best radio book you have seen, return it and owe nothing. If you keep it, send the price of \$6.00 within ten days.

Order on This Coupon

D. Van Nostrand Co., Inc.,
250 Fourth Ave., New York.

Send me the Revised edition of THE RADIO MANUAL for examination. Within ten days after receipt I will either return the volume or send you \$6.00, the price in full. Radio-Craft 2-30

Name

St. & No.

City and State

Orders - Inquiries

60 pages
Send for FREE Copy

Can be Secured by MAIL



POLK'S REFERENCE BOOK and Mailing List Catalog

Gives counts and prices on over 8,000 different lines of business. No matter what your business, in this book you will find the number of your prospective customers listed. Valuable information showing how to use the mails to secure orders and inquiries for your products or services is given.

Write for FREE Copy
R. L. POLK & CO., Detroit, Mich.
Largest City Directory Publishers in the World. Branches in Principal Cities
Mailing List Compilers—Business Statistics
Producers of Direct Mail Advertising

PATENTS

Protect Your Ideas

Write for Instructions, free on request - - or send drawing or model for preliminary examination of Patent Office records

Promptness Assured with Best Results

Carl Miller
PATENT ATTORNEY

Former Member Examining Corps, U. S. Patent Office
265 McGILL Building, Washington, D. C.

CORWICO

VULCAN

Lightning Arrester

\$1



\$100 Guarantee Against Lightning Damage Enclosed in Each Box. It Also Dissipates Accumulated Static Charges.
At Your Dealer or Direct
CORNISH WIRE COMPANY
36 Church Street, New York City
Makers of Corwico BRAIDITE Hook-Up Wire

Setting of gain controls (volume control for differently pitched horns) for horns? Condition of each and every tube? Condition of the various circuits? Condition of machine: (1) appearance, (2) electrically, (3) mechanically, (4) any vibration? Condition of motor-control boxes? Condition and complete readings of storage batteries, "B" and "C" batteries. Condition of horns? Correctly placed? Type of screen, its condition? Acoustics? Remarks of projectionists? Remarks of house manager? General remarks and recommendations?

The above questions, and many more, are subdivided so that the report covers items specifically rather than generally. To make out this report the Service Man must test out, for practically every question.

The Service Man has a regular route of theaters, to which he makes these periodic visits; and he stands ready at any time to answer emergency calls at any one of these.

Future Articles

Upon consideration of the various phases of Sound Projection which the author has touched here but lightly, it is seen that the field now embraces technicalities quite undreamed of a few years ago. Each of the specific divisions of sound reproduction has made a place for a technician, specializing in just that particular branch of the art.

Now, if every reader of RADIO-CRAFT interested in this subject will accept an invitation to offer suggestions and comments on the phases of Sound Projection of the greatest general interest and benefit, the writer will be glad to incorporate this information in a series of discussions, of which this story is respectfully submitted as the first.

In future articles the writer will dig into the mechanics of Sound Projection; and he will endeavor to answer in the articles all the inquiries of general interest which may be addressed to the author, in care of RADIO-CRAFT Magazine.

GLOSSARY
of "Sound" Technical Terms
(Continued from page 379)

S

Service Man—Service Men may be classed as either "sound" men or "machine" men; depending upon whether they maintain the adjustment of the sound equipment or that of the picture mechanism.

Sets—The scenery of a motion picture on the "lot" where it is produced.

Silent Equipment—Projectors not equipped with sound-reproducing apparatus.

Sound Engineer—A technician with an extensive knowledge of sound equipment, theory and operation.

Sound-on-Disc—The type of sound projection where the sound is recorded on a phonograph record. This record is run at the same time as the film.

Sound-on-Film—The type of sound projection where the sound is photographically recorded (as a "sound track") on the picture film.

NOW On All Newsstands

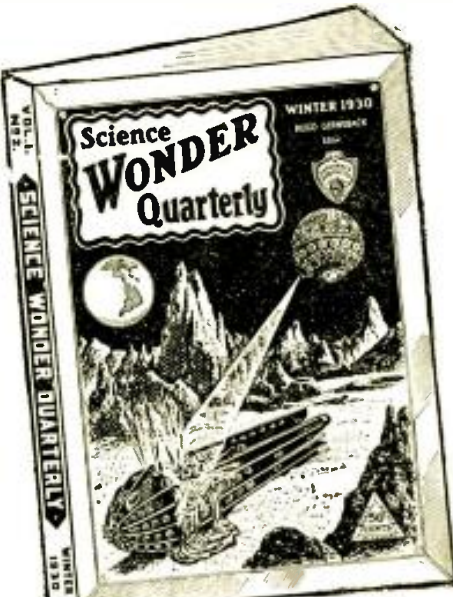

144 PAGES
4-COLOR COVER

THE MOON CONQUERORS
By R. H. Romans

Mr. Romans is a modern Jules Verne and his story of two planets will undoubtedly rank with the "Shot Into Infinity" as one of the best interplanetary stories of recent years.

AMONG THE OTHER STORIES ARE:

INTO THE 28TH CENTURY
By Lilith Lorraine

THE OSMOTIC THEOREM
By Capt. S. P. Meeks, U. S. A.

The subscription price of the QUARTERLY is \$1.75 per year, single copy 50c.
To new subscribers, a special price of \$1.25 per year is now available. This offer will positively be withdrawn after February 1, 1930.

50c The Copy

On All Newsstands or mail coupon



STELLAR PUBLISHING CORP.,
Dept. RC-2, 98 Park Place, New York, N. Y.

Enclosed please find \$1.25 for which send me the next 4 issues of SCIENCE WONDER QUARTERLY. (Canada and foreign \$1.50.)

Name

Address

City..... State.....

Sound Film—(See Synchronized Film.)

Sound Pick-up—The device that transforms the physical sound recording to electrical vibrations. Usually used in reference to disc recording.

Sound Picture—A moving picture accompanied with talk, music, or special sound effects.

Sound Projection—The operation of sound picture equipment.

Sound Projectionist—One who is skilled in both the theory and the practice of sound equipment, mechanics, electricity and showmanship.

Sound Reproduction — Re-creation of the sound recording that accompanies sound pictures: whether disc or film sound.

Sound Technician—A specialist on sound apparatus. Not necessarily as well-trained as the sound engineer. Usually a specialist on sound branch of sound recording or projection.

Sound Track—That portion of the picture film which carries the photographic record of the original sound.

Spot—The concentration of light on the film, as it passes the aperture plate.

Sprocket—A small wheel containing teeth corresponding to the holes in the film; with which they engage, and thus drive the film forward.

Standard Camera Speed—A film speed of 90 feet per minute.

Standard Turntable Speed—The rotational speed of the record table, and therefore the record; approximately 33 2/3 r.p.m.

Studio Film Operator—One who selects, inspects, or otherwise handles the film at the studio.

Starting Point of Record—A guiding-groove on the sound record, starting at a certain distance from the remainder of the sound recording. An arrow points to a particular point on the groove marked "Start," at which pick-up needle is to be placed.

"Sync"—(A contraction of "synchronism," which see.)

Synchronism—This term refers to the time relationship which must be maintained between picture and sound. To be in synchronism, the sound equipment must not only operate at the same time as the picture, but it must also keep in exact "step" with the corresponding action of the picture. Where sound equipment operates in conjunction with the picture, but only as a general accompaniment, thus not requiring an exact "step" relation of sound and action, it is known as "non-sync" (non-synchronous).

Synchronized Film—A picture film which has a counterpart in sound, recorded on a disc.

Dr. James Harris Rogers, the distinguished radio inventor, died on December 12th, at his home in Hyattsville, Maryland, at the age of 79. Already distinguished as an inventor of electrical and telegraphic devices as early as 1872, he took up radio development with enthusiasm in his later years and in 1908 began investigating submarine and subterranean (buried) aeriads. During the war, he placed these inventions at the disposal of the United States Government, and they materially aided the Intelligence Services of the Army and Navy. In 1919 he received the official thanks of the state of Maryland for his scientific work. Dr. Rogers remained active until the end, which came suddenly.

Jenkins Radiovisor

(Continued from page 383)

an absolute minimum. The effect of regeneration is to sharpen tuning excessively, and when the detector oscillates, the television picture will have a checker-board pattern.

So critical are the requirements of good radiovision reception that we have found it necessary to develop a special short-wave receiver for the purpose. The result is the Jenkins non-regenerative short-wave radiovision receiver, which will shortly be made available to the public, and which incorporates the various features we have explained.

(In the March issue of RADIO-CRAFT, Mr. Replogle will continue his explanation of the design of radiovision receivers, and of the practical problems of television reception.—Editor.)

Modernistic Speaker

(Continued from page 390)

genious, small springs or ordinary bristles may be substituted for the legs of the dolls and the vibration of the speaker will cause the dolls to dance about. In this case, a little platform must be built and extended in front of the smaller frame.

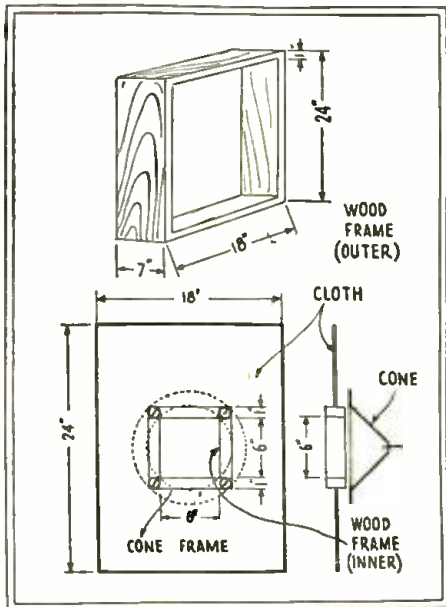

Fig. A (above) Fig. B (lower)

Constructional details of the loud speaker illustrated on page 390. The decorative front functions as a baffle and improves the quality of r production.

Over the Mountains from Los Angeles



Think of it! FIVE HUNDRED FIFTY-NINE MILES over rough mountainous country burning only ELEVEN GALLONS OF GASOLINE. Imagine more than FIFTY MILES TO THE GALLON. That is what the WHIRLWIND CARBURETING DEVICE does for D. R. Gilbert, enough of a saving on just one trip to more than pay the cost of the Whirlwind.

THE WHIRLWIND SAVES MOTORISTS MILLIONS OF DOLLARS YEARLY

Whirlwind users, reporting the results of their tests, are amazed at the results they are getting. Letters keep streaming into the office telling of mileages all the way from 22 to 59 miles on a gallon, resulting in a saving of from 25% to 50% in gas bills alone. Mark A. Estes writes, "I was making 17 miles to the gallon on my Pontiac Coupe. Today, with the Whirlwind, I am making 35.5-10 miles to the gallon." P. P. Goerzen writes: "34-6-10 miles with the Whirlwind, or a gain of 21 miles to the gallon." R. J. Tulp: "The Whirlwind increased the mileage on our Ford truck from 12 to 26 miles to gallon and 25% in speed." Car owners all over the world are saving money every day with the Whirlwind, besides having better operating motors. Think what this means on your own car. Figure up your savings—enough for a radio—a bank account—added pleasures. Why let the Oil Companies profit by your waste? Find out about this amazing little device that will pay for itself every few weeks.

FITS ALL CARS

In just a few minutes the Whirlwind can be installed on any make of car, truck or tractor. It's actually less work than changing your oil, or putting water in your battery. No drilling, tapping or changes of any kind necessary. It is guaranteed to work perfectly on any make of car, truck or tractor, large or small, new model or old model. The more you drive the more you will save.

SALESMEN AND DISTRIBUTORS WANTED FREE SAMPLE AND \$100.00 A WEEK OFFER

Whirlwind men are making big profits supplying this fast selling device that car owners cannot afford to be without. Good territory is still open. Free sample offer and full particulars sent on request. Just check the coupon.

GUARANTEE

No matter what kind of a car you have, no matter how big a gas eater it is—The Whirlwind will save you money. We absolutely guarantee that the Whirlwind will more than save its cost in gasoline alone within thirty days, or the trial will cost you nothing. We invite you to test it at our risk and expense. You are to be the sole judge.

FREE TRIAL COUPON

Whirlwind Mfg. Co., 999-112-A Third St., Milwaukee, Wis. Gentlemen: You may send me full particulars of your Whirlwind Carbureting device and free trial offer. This does not obligate me in any way whatever.

NAME ADDRESS CITY COUNTY STATE Check here if you are interested in full or part time salesman position.

TRI-STATE HEADQUARTERS Pennsylvania—Ohio—West Va. WHOLESALE RADIO To DEALERS and SET BUILDERS we offer the most prompt and efficient service. We handle only the best merchandise and give MAXIMUM DISCOUNTS. GET OUR CATALOG CAMERADIO C.R.O. 430 WOOD ST. at Diamond St. PITTSBURGH PA.

MEN ARE IN DEMAND

In All Branches of Radio Prepare through a school with a reputation for efficiency. Our courses are easy, interesting and effective. We have large classrooms, laboratory, workshop, dormitory and many other new and unusual features. Subjects Taught: Laboratory, Commercial Radio, Radio Service, Radio Broadcast, Navigation, Vitaphone-Movietone, Radio Mathematics, Literature on Request

COMMERCIAL RADIO INSTITUTE 38 W. BIDDLE ST. FOUNDED 1920 BALTIMORE, MD.

Read what engineers have to say about Rider's "Trouble Shooter's Manual"

RADIO CORPORATION OF PENNSYLVANIA
331 Fourth Avenue
Pittsburgh, Pa.

August 23, 1929.

Radio Treatise Co.,
1440 Broadway, New York City.

Gentlemen:

We have received John F. Rider's "Trouble Shooter's Manual" which our instructors, who are Westinghouse Electric and Manufacturing Company and Radio Corporation of America engineers, recommend highly and say that all of our radiotrician students should have a copy.

Very truly yours,
Radio Corporation of Pennsylvania,
(Signed) W. R. Jones,
Business Manager.

Is a higher recommendation possible? You too, if you are interested in radio and radio service will find Rider's

"TROUBLE SHOOTER'S MANUAL"

of infinite value. Wiring diagrams of more than 200 models of radio receivers . . . Trouble Shooting information . . . How to find the trouble . . . The possible troubles and symptoms in radio frequency amplifiers—detectors—audio frequency amplifiers—A eliminators—B eliminators—a wealth of vital money-making information . . . THE BOOK WILL BE WORTH HUNDREDS OF DOLLARS TO YOU . . . 22 chapters of vital information—the kind of dope you need in your service business . . .

Wiring Diagrams of These Commercial Receivers

- | | |
|----------------------|-------------------|
| Radio Corp. of Amer. | Federal |
| Atwater-Kent | Crosley |
| Zenith | Majestic |
| Fada | Stromberg-Carlson |
| Stewart-Warner | Grebe |
| Philco | Freshman |
| Freed-Eisemann | Kolster |
| All-American | Day-Fan |
| Colonial | Workrite |
| Amrad | Sparton |
| DeForest | Ware |
| Garod | Kennedy |
| Operadio | Sleeper |
| Magnavox | Grimes |
- 240 PAGES 8 1/4" x 11", BLACK STURDITE BINDING

RADIO TREATISE CO.
1440 Broadway, New York City
Send No Money

RADIO TREATISE CO.,
1440 Broadway, New York City.

Send me John F. Rider's "Trouble Shooter's Manual" and I will pay postman \$3.50 plus a few cents for postage on delivery. It is understood that my money will be refunded if I am not entirely satisfied.

Name

Address

City..... State.....

Heinrich Hertz

(Continued from page 375)

nothing to do directly with the path of the current"; and in the same year, the invention of the hot-wire ammeter for high-frequency current.

In 1883, Helmholtz proposed to his young friend an inquiry into the electromagnetic theory of Clerk Maxwell. The fruits of this study, four years later, carried to the world the proof of the existence of radio. In 1887, working under many difficulties, Hertz proved, with his simple apparatus, that electromagnetic radiation, in wavelengths from three meters down, can be created, and that it follows the law already recognized in the behavior of the immensely shorter waves of light.

"All propagation of electrical disturbances," he announced, "takes place through non-conductors; and conductors oppose this propagation which, in the case of rapid alternations, is insuperable." In the same year Hertz, examining into spark-gap discharges (the rather crude means by which he was able to detect the presence of radio waves by the currents which they set up in a resonant circuit) found that the existence of one spark affected the length of another; and finally trailed down the reason to the presence of ultra-violet light—which we now know to cause ionization, and consequently greater conductivity, of the air.

Intensely chivalrous, Hertz exemplified in his modest announcements to the scientific world the utmost desire that all of the theorists and discoverers who had preceded him should have their full share of credit toward the pyramid of achievement he had reared on the previous bases. He was in, truth, the very knight of science; self-effacing, seeking no personal distinction, but only to advance the progress of truth, and let the glory fall where it would. "I have carried out with the greatest possible care these experiments (by no means easy ones) although they were in opposition to my preconceived views"; he wrote, and accepted with generous approval, the results of better-equipped experimenters.

The conclusions of Hertz, derived from the study of what we would now class as ultra-short radiation, have never been carried out in practical exploitation to their full limit. After longer waves had been found, in practice, most suited to distant communication, radio practice has swung back, year by year, toward shorter wavelengths. The phenomenon of wave reflection has been employed in directional-beam transmission and reception; that of plane polarization has been experimentally utilized; but as yet the refraction of waves (demonstrated by Hertz with a large prism of pitch in his laboratory) has been put to no practical account. However, as work with ultra-short waves proceeds down to the lengths of less than a meter, we may expect to see radio projectors using lenses like those of a searchlight, and possibly receivers like telescopes.

"It is a fascinating idea, that the processes in air which we have been investigating represent to us on a millionfold-larger scale the same processes which go on in the neighborhood of a Fresnel mirror, or between the glass plates used for exhibiting Newton's rings," wrote Hertz, describing

New Profits For

- Radiotricians
Professionals
Engineers
Mechanics
Consultants
Designers
Service Men
Contractors
Manufacturers
Dealers**

In order to make it possible for all Radio Technicians to read RADIO-CRAFT regularly, each month, we have put into effect a special subscription price.

The regular price of RADIO-CRAFT is \$2.50 per year (12 issues). The newsstand rate is 25 cents a copy.

Any radio professional, sending in a subscription on his letterhead, showing that he is engaged in some capacity in radio work will receive as a special courtesy

EIGHT ISSUES OF



FOR ONE DOLLAR

Just pin a dollar bill to the coupon below and forward it with your letterhead or business card.

RADIO-CRAFT,
RC-2, 98 Park Place,
New York, N. Y.

Enclosed find \$1.00 for which please enter my subscription to RADIO-CRAFT for eight months.

Name

Address

City..... State.....

some of the experiments which he has made classic. (They are described in the January issue of RADIO-CRAFT, on page 312).

The experiments of Hertz lacked, undoubtedly, the publicity with which today's press would have greeted them; but, in the world of science, they gained for the modest professor immediate recognition, just as his fine personality commanded the esteem of all who met him.

Appointment to the chair of physics at the University of Bonn (where he was to end his days) was welcomed by him, for the added research facilities which were thus placed at his disposal. He there added nothing sensational to the knowledge of the great subject which he had so masterfully handled; but it may be noted that, in 1891, Hertz found that cathode rays pass through metal, thus anticipating the inquiries into the X-ray which have been of such scientific and medical value. His last work was a treatise on "The Principles of Mechanics." Hertz possessed the faculty, not always found among great scientists, of dealing with abstruse subjects in a popular manner; and his lecture to the Heidelberg Association for the Advancement of Science on his discoveries is a classic of this nature. Its closing words may appropriately be quoted here:

"We have found a starting point for further attempts, which is a stage higher than any used before. Here the path does not end abruptly in a rocky way; the first steps that we can see form a gentle ascent, and among the rocks there are tracks leading upward. There is no lack of eager and practiced explorers; how can we feel otherwise than hopeful of the success of future attempts?"

How well this prediction of Hertz is to be fulfilled, time is still telling. The young explorer in the untrodden ways of science was cut off in his prime; but the paths he indicated are thronged and frequented by those who reverence his name.

A graceful tribute is paid to the memory of Hertz by his countrymen, who place his name in the daily speech of radio beside those of his predecessors, Volta, Ohm, Ampere, Faraday and Henry. The "Hertz" is the unit of frequency, a cycle of alternation per second; most used in its multiple, the "kilohertz" (kilocycle). The more general use of this term would be a well-deserved international tribute to a man who has merited much from the entire human race, who are his beneficiaries.

The rare autograph and photograph of Professor Hertz, which RADIO-CRAFT has been privileged to reproduce, is from the large collection of Major William J. Hammer, of New York, a distinguished electrical engineer, and former vice-president of the A. I. E. E. and the New York Electrical Society. Major Hammer, who was intimately associated with Edison during the development of the electric lamp and its commercial introduction, was in 1889 Edison's personal representative at the Paris exposition, and later accompanied Mr. and Mrs. Edison to the German Scientific congress at Heidelberg. At this time Major Hammer made many acquaintances among European scientists; and he later obtained from Dr. Hertz the original photograph, with the autograph, which remains among the most-prized of the treasures which he has assembled.

A "Composite" Receiver

(Continued from page 387)

grooves about 3/32-inch deep, and a third slot endwise in the form, as shown in Fig. 4. Into each end of the form bore a hole and tap it (4/36 or 6/32) for making connection to the lead wires. Using No. 36 or No. 40 enamelled wire (the wire from a discarded audio-frequency transformer is satisfactory) wind fifty turns of wire in the first slot; and carry the wire through the vertical slot to the next circular groove, where fifty more turns should be wound. Solder the two ends of the wire to the heads of the two screws provided in the ends of the form. The choke thus formed is mounted between spring clips such as are used to hold tubular resistors and grid leaks. The inductance of the choke is of suitable value for the high frequencies and the separation of the two halves of the winding makes a series connection of the capacities between turns, reducing the total capacity of the choke to a very small value.

Three of the chokes are mounted on strips of bakelite or formica of suitable size, merely to accommodate the choke and its supporting clips. The fourth choke, used in the screen-grid input circuit, is mounted (as shown in Fig. 5) on a piece of bakelite two inches wide and five inches long. The clips for mounting the choke are placed across one end of the insulating strip, and an additional pair of clips, somewhat larger and stiffer, is provided for mounting a flashlight battery cell. A one-tenth microfarad by-pass condenser, mounted beside the battery cell, completes the assembly of the screen-grid tube's input circuit. It is mounted, with the choke at the top, on the inner side of the front panel adjacent to the screen-grid tube. This assembly and its mounting insure a minimum of connecting wire, and provide that the lead to the control grid of the tube shall be very short and remote from all other lead wires, a matter of extreme importance. The antenna lead, connecting as it does to the same point on the choke as the lead to the control grid, should be suitably spaced from all other wires to avoid feed-back currents. Carrying the antenna lead into the receiver directly through the front panel, while not strictly "up-to-the-mode" in receiver design, is a very satisfactory disposition of the antenna lead in this receiver. It needs no emphasis that the antenna binding post should be properly insulated from the panel by bushings.

Coil Specifications

The tuning inductances L, three in number, are of special design and must be homemade. The general plan of the coil is shown in Fig. 3 at a. It will be noted that the coil is perfectly rigid and substantial, yet has a minimum of dielectric within the immediate field of the coil. With this construction the turns may be easily spaced at any desirable distance apart in such fashion that the spacing is permanent. To make the coil a section of bakelite tubing 2 1/2 inches in diameter is sawed lengthwise into three equal sections as at b. Two pieces 1 inch long, two pieces 1 1/4 inches long, and two pieces 2 inches long may be cut from a 3 1/4-inch length of tubing. A 1/8-inch slot is cut at the middle point of each piece for half

MAKE GOOD RECEPTION EASY



Thousands of users marvel at the difference in reception with a Townsend "B" Power Unit. Full, sweet tone, clarity, volume and greater distance are among the many advantages reported daily.



TOWNSEND "B" POWER UNIT

Hooked up in a few minutes; just plug into the light socket and forget it. Delivers up to 100 volts on any set—D.C. or A.C.—any cycle.

Approved and passed by the rigid laboratory tests of "Popular Radio" and "Radio News."

Over 150,000 Now in Use!

There's no longer any reason for putting up with the expense and undependable performance of "B" Batteries—when you can own a good "B" Power Unit for \$6.85. Over 150,000 Townsend "B" Power Units now in use—a substantial proof of satisfaction.

Send Only \$1.00

Send name and address with only \$1.00. On arrival of Townsend Power Unit pay postman \$5.85 plus postage. Try out ten days, then, if it fails to do everything we say, return it and money paid us will be refunded. Make a REAL receiver of your set.

Beats 135-Volt "B" Batteries

Your Eliminator is very satisfactory. I had been using three 45-volt "B" batteries with my set, but I get better results from your 90-volt Eliminator than I got from the 135 volts of "B" batteries.

Joseph Mallen, Providence, R. I.

Send for Literature

TOWNSEND LABORATORIES
723 Townsend St. Chicago, Ill.



Get your radio operator's license!

This book gives information necessary to men who are preparing to become licensed amateur or commercial radio operators. It gives explanatory answers to hundreds of questions which are asked in government examinations.

Radio Operating Questions and Answers

By Arthur R. Nilson and J. L. Hornung

267 pages, 5 1/2 x 8, 91 illustrations \$2.00 postpaid

The revision of this practical book covers all advances which have been made in radio communication in the past several years. It takes into consideration the new technique of broadcast station operation. The volume presents a complete source of information covering any question which might be put to you in a government test qualifying you for an amateur rating or any class of commercial shore or ship operating.

FREE EXAMINATION COUPON

McGraw-Hill Book Company, Inc.,
370 Seventh Avenue, New York, N. Y.

Gentlemen:
You may send me Nilson and Hornung's RADIO OPERATING QUESTIONS AND ANSWERS, \$2.00 postpaid. I will either return the book, postage prepaid, in 10 days, or remit for it at that time.

Name

Home Address

City and State

Position

Name of Company

R.C. 2-30

NEW
BISMARCK
HOTEL

Randolph at La Salle

A modern hotel where the hospitality of yesterday is enhanced by the cheering luxuries of today.

Light, airy rooms—beautifully furnished and providing home-like comfort.

Famous for good food.

Rooms \$2.50 and up
With Bath \$3.50 and up

CHICAGO

Can You Outguess
O. Henry?

Can you look ahead in an O. Henry story and see the unexpected denouement, the strange twists of plot, the breath-taking finish? Try it? If you succeed you can out-think the best minds in the world, for the genius of O. Henry sets the wits of the brilliant people of all lands working at top speed—and still he amazed them all! He is the supreme master of the "trick" ending, luring you into sudden laughter while a lump still lingers in your throat—making you gasp by a sudden vivid flash of horror in the midst of a smoothly flowing tale.

Stories of Wit and Pathos

Gentle is O. Henry, but manly strength glows in every virile sentence; tender with the suffering; ever kind to the under dog; chuckling with the light-hearted—drawing always from his unplumbed depths of understanding the sparkling crystal of sincerity. A great writer, yet the most entertaining and thrilling companion. Reading his stories is like listening to a

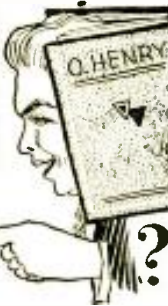

The Master
Story
Teller

more brilliant story-teller than you ever knew. His works immeasurably enrich the limited library, and grace the shelves of the most crowded.

53 BEST STORIES

Less than **\$1.97**
4 cents each

You are now offered for the first time 53 engrossing, living, selected stories, handsomely and durably bound in leatherette, stamped with gold, 500 pages, all for the price of only one ordinary short novel.

CUT PRICE COUPON

GRENPARK COMPANY, Dept. R.C.-230,
245 Greenwich St., New York, N. Y.

Please send me O. Henry's Best Stories at the cut price of \$1.97. I enclose stamps, check or M. O. for the amount. (check which)

Name

Address

City and State

Why
DO YOU
READ?

For entertainment? For escape from daily drabness? For romance, adventure, thrills? To sharpen your wits or exercise your emotions? Whatever your reason, O. Henry scores a bull's-eye on every point.

the length of the piece, and notches are filed in the edges for spacing the wire. For each coil a flat piece of bakelite 1/8-inch thick, 2 1/2 inches wide, and one inch longer than the curved pieces with which it will be used, is needed.

The dimensions and form of the flat strip for the smallest coil is shown in Fig. 3 at c. The lower projection is provided for mounting the finished coil in a vacuum-tube base. The secondaries of the coils are wound with No. 16 soft annealed copper wire, and the ticklers are wound with No. 26 D.S.C. wire. The secondary wire should be bare. When wound, the projecting lower section of the coil form should be thrust into the tube base and the leads should be soldered to the prongs, the top of the secondary going to the plate prong, and the bottom to the "F+" prong. The top of the tickler should go to "F—" and the bottom to the grid prong. The shell is then filled up with sealing wax or transformer compound, and the coil is ready for use. When mounted in a standard UX tube base, the lower end of the coil is separated from the sub-panel by about two inches, which is another point of merit of the coil.

No exact dimensions are included in the layout plan; since the exact position of the various parts will be largely determined by the size and shape of the parts used. It is hoped, however, that the constructor will not depart from the general layout plan in any important detail; for it is in the layout that much of the merit of this receiver is to be found.

The receiver is tuned in much the same fashion as all regenerative receivers. Some of the more powerful stations can be tuned without making use of the regeneration whistle; but for the most part the regeneration control will be advanced until there is a slight noise as of rushing water, and the tuning control advanced very slowly until a station whistle is heard. The regeneration control is then turned back until the whistle disappears. Some little difficulty may be experienced by the novice in short waves in clearing up stations, because the tuning is very sharp; but after a little experience he will be able to clear up regeneration noises and tune in stations the wide world over.

The total cost of the receiver above described, exclusive of the tubes, should not exceed twenty dollars, and by using sockets, resistors, and other parts found in every junk box, the total outlay can again be very materially reduced. The list of parts used, including tubes, is as follows:

List of Parts

- One Pilot variable (tuning) condenser, .00016-mf., C1;
- One Pilot variable (regeneration) condenser, .00025-mf., C2;
- Two Jefferson "Star" audio transformers, T1-T2;
- Four by-pass condensers; one 0.1-mf., C; two Dubilier 1-mf., C4-C5; one Sangamo .001-mf., C6;
- One Sangamo grid condenser, .0001-mf., C3;
- Four special radio-frequency chokes, made as described, RFC1-2-3-4;
- Bakelite tubing, etc., for plug-in coils L, as described;
- One Amperite No. 622, R1;
- One Pilot screen-grid-tube shield and socket, S;

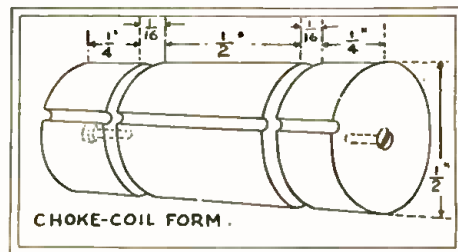

Fig. 4

Design of home-made R.F. chokes for use in the composite receiver. The self-capacity is low.

- Four Kelford UX tube sockets, for L and V2-3-4;
- One Cunningham UX-322 screen-grid tube, V1;
- One Cunningham 301A tube, V3;
- Two Cunningham 312A tubes, V2-V4;
- One Polymet 4-megohm grid leak, R;
- Three 1/4-amp. filament-ballast resistors, R2-3-4;
- One brass panel, 7x16 inches, and sub-panel, 11x16 inches;
- Celatsite hook-up wire, bakelite strip, lugs, screws, clips, etc.;
- One Burgess 1 1/2-volt flashlight cell to bias tube V1, "Batt."

The dimensions of the three coils needed are as follows:

	Length Inches	L1 Turns	L1 Spacing Inches	L2 Turns
No. 1	1	3 1/2	3/16	3 1/2
No. 2	1 1/4	6 1/2	1/8	4 1/2
No. 3	2	12	1/8	7

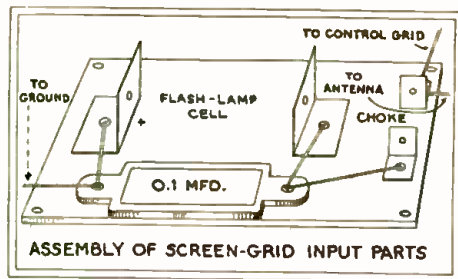

Fig. 5

The antenna connection indicated in Figs. 1 and 2 is shown here in more detail. The base is bakelite.

Airplane Radio

(Continued from page 385)

they will be guided on their respective courses by radio beacons; and ground stations will be constantly in touch with each other, knowing at all times exactly what conditions are and at what point their winged messengers are flying.

Eleven radiophone ground stations will be constructed in seven states and a complete express and passenger air route will augment the present mail service to be controlled by the new system. The ground stations will be built by the company under special Federal permits of supervision. The resultant close control of the service will result in added safety of flying, reducing the number of forced landings due to uncertainty of weather conditions ahead, according to engineers.

Radio Beacons to Be Guides

The radio system will also be connected with the detailed weather broadcasts of the

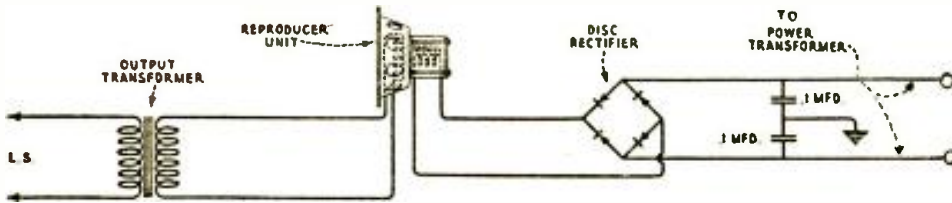

Fig. 2

Above: Schematic circuit of field-current supply for the Radiola "41-AC" dynamic reproducer. The rectifier units at either side should be tested, if line-fuses blow, or if a hum develops in the reproducer.

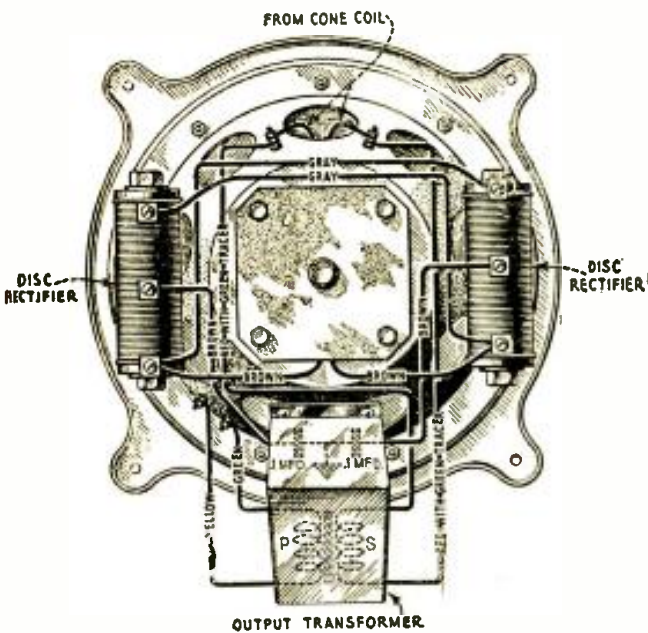

Fig. 2A

Left: Graphic representation of the parts which constitute the "41-AC" reproducer, described by Mr. Freed, showing the position of each component. The "disc" or "dry" rectifiers are the particular items under consideration. They may readily be replaced.

Department of Commerce, which are maintained for the safety of airmail pilots. Planes will be guided by the radio-beacon system, in which the pilot travels along between two waves of different frequency. (As he turns to either side, the sound of the other becomes less pronounced, and he can thus determine whether he is to the right or left of his course.) The Department of Commerce has established stations every 150 miles along the route; and the planes will be required to receive additional information in flight through regular government broadcast channels.

Radiophone has become imperative, with the early prospect of planes in and out every hour at large terminals, and the development of this new system materially changes the aspect of air transportation.

Much trouble is encountered in overcoming some of the obstacles in making the system practical; but recent experiments show that pilots can talk at 175 miles in a natural tone, and that operators have communicated with ground stations from altitudes as high as 19,000 feet—with better success than at low altitudes because of the absence of "ground absorption." This is an aircraft contribution to the radio art.

Another feature of the new system will enable passengers to talk to city telephone users, by relaying a call through the ground station of the line. This, as a commercial practice, however, is not permitted at present by the Department of Commerce; which stipulates in its special permit that only messages dealing with the operation of planes and "protection of life and equipment" shall be broadcast through the sets on the planes.

Commercial telephone service to the *SS. Leviathan* at sea is now available, after extensive short-wave radio experiments.

Operating Notes

(Continued from page 368)

a ground of the pilot light to the chassis (Fig. 5).

In the Colonial "31DC" a short between the primary and secondary of the push-pull input transformer may be quickly determined by testing (with battery and voltmeter) across the D.C. input plug, with the tuner-chassis plug removed from the pack. Any partial reading is an indicator of a bad transformer; no reading means no trouble.

The Bosc "28" and "29" have a single resistor to bias the three R.F., detector and first audio stages; the center taps of the filament-balance resistors go to the same 500-ohm resistor, which is connected to "B—" (Fig. 4).

The new Zenith "52" has two stages of screen-grid R.F., a screen-grid detector and three audio stages—one '27 in the first, push-pull '27s in the second, and push-pull '45s in the power stage. If this receiver blasts on high volume, try reducing the plate voltage of the '45s by placing a resistor in the lead to the center tap of the output impedance.

MIXED WIRES!

WHEN talking-movie equipment was being installed in the "cinema" of a small English town, says *Variety*, owing to the mixing of some wires, contact was made to the town's main telephone cable.

When the picture was run on the projectors every phone bell in the town rang and the subscribers, on lifting their receivers, heard the opening bars of the film's synchronized accompaniment. Strain on the fuses proved too much and they blew out.



WRITE for This 48 Page MANUAL

Full of **RADIO DATA**

Useful to the **CUSTOM-BUILDER and ADVANCED FAN**

Describes the newest and finest

- BAND-FILTER TUNING**
- SCREEN-GRID AMPLIFIER — PUSH-PULL POWER AMPLIFIER — POWER PACK — UNIT CONSTRUCTION — EFFECTIVE SHIELDING — SPEAKERS — CABINETS — INSTALLATION — SERVICING.**

It will make money for you; it will save money for you.

Write for it today. Use the convenient coupon.

Hammarlund-Roberts, Inc., Dept. R.C.2, 424-438 W. 33rd St., New York.

Enclosed 25c (stamps or coin) for "HIQ-30" Manual.

Name _____

Address _____





There's **an AMPERITE** for **Every Tube-in-Every Circuit!**

Any radio tube, A. C. or D. C., regardless of make or type, works best when AMPERITE-controlled. AMPERITE prevents the voltage fluctuations which ruin tubes. Every worthwhile circuit deserves AMPERITE automatic tube control.

\$1.10, with mounting (in U. S. A.) At all dealers

AMPERITE Corporation
561 BROADWAY NEW YORK
FREE "Amperite Tube Chart." Write Dept. RC2



Write for Information about the **NEW H-F-L MASTERTONE**

LABORATORY MADE RECEIVER
The Year's Outstanding Radio Achievement

HIGH FREQUENCY LABORATORIES
28 N. Sheldon St. Dept. 73 Chicago, Ill.

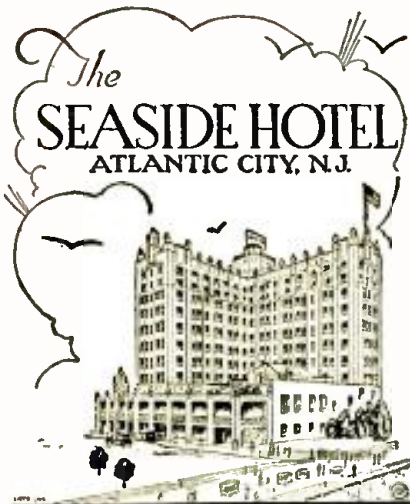

1873-1930

NEW in construction and furnishings — OLD in hospitable traditions.

Famous for its home-like atmosphere. The SEASIDE is a rare combination of a thoroughly modern hotel and a great private home with your friends about you.

AMERICAN PLAN

- Single rooms, running water, \$5 a day, \$30 a week up
- Double rooms, running water, \$10 a day, \$56 a week up
- Single rooms, private bath, \$7 a day, \$42 a week up
- Double rooms, private bath, \$14 a day, \$70 a week up

COOK'S SONS CORPORATION

Cooperative Laboratory

(Continued from page 392)

between the positive end of the circuit and the filaments. This difference of potential is our only source of "B" supply.

The actual voltage encountered on a so-called "110-volt" D.C. line, under average conditions, is actually about 115. We have accordingly shown this value in the various sketches. It is apparent from the diagram, so far discussed, that the filaments and the 10-ohm rheostat consume 20 volts. This leaves only 95 volts available for the push-pull power stage. You may think this insufficient; but the mere fact that a power tube is rated at 180 volts, maximum, is no reason why it will not perform fairly well at 95 volts. The only precaution to be exercised is a proportional reduction in the "C" bias, which should only be about 15 volts in this case, instead of the regular 40 volts bias with which you are familiar. Nevertheless, every volt does count and we can ill afford to waste any in the resistance introduced by any filtering contraption.

Exhaustive tests have shown that no filter is required in the "B" lead to the power stages. This is because there is no subsequent amplification, without which a commutator hum is not apparent. A similar condition was discovered to exist in the two R.F. stages, where the hum could affect only the carrier wave; it is not of sufficient strength to do this. The only difference between the "B" supply leads, for the power stage and for the R.F. stages, is the installation in the latter of a potentiometer to regulate the voltage on the plates and the consequent volume of signal received. Reference should here be made to Fig. 2.

Obtaining "C" Bias

The "B" supply for the detector and first audio stage *must be filtered*: this has found absolutely essential, for these circuits constitute two of the three real sources of possible noise. Filtering in this position presents no particular difficulties, because the current drain is exceptionally small and a slight decrease in voltage may be tolerated. This is illustrated in Fig. 3. We employ a "C"-bias detector, because of its superior tone quality on loud signals; this detector works directly into a resistance-coupled audio stage, before passing on to the push-pull power stage. It must be apparent that the detector normally draws no current, being operated with an abnormal bias; and the first audio stage draws only a few mills at the 90-some volts on which it is operated. This exceptionally small current drain permits the use of most any type of audio choke as the filter coil; even the secondary of an old audio transformer may be utilized here. The 2-mf. condenser inserted between the plate side of the choke and the common filament lead, connecting the detector and first audio tubes, is the only filter condenser required in the whole set. The customary condenser, which ordinarily appears on the high-voltage side of a filter choke coil, is replaced, in our circuit, by the high capacity existing in the power lines themselves.

We are now ready for a discussion of the respective "C"-bias circuits, and will start with the radio-frequency stages. The grid returns from the radio-frequency tubes are

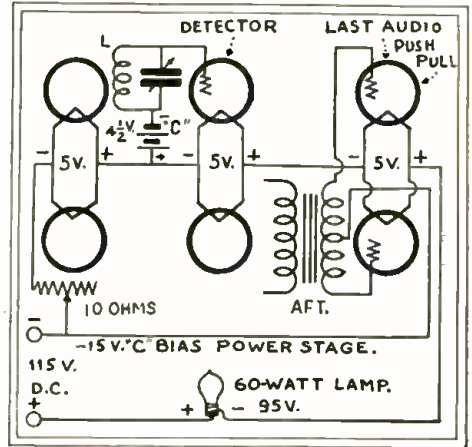

Fig. 5

The detector can be biased satisfactorily only by a battery. The audio tubes take the full drop across the line.

brought back to the extreme negative end of the power lines. This places thereon a variable negative bias, depending upon the adjustment of the variable 10-ohm rheostat. This bias may be changed from zero to minus 5 volts; which is quite satisfactory for the maximum of 110 volts applied to the plates. The "C" bias for the first audio stage is secured by returning the lead to the negative end of the radio-frequency filaments; this gives a 5-volt negative bias to the grid of this stage—the proper amount for the 100-some volts on the plate. Of course, the 15-volt bias for the push-pull power stage is obtained by returning this lead to the extreme negative end of the line; where it receives the total voltage drop across the remaining tubes and the variable 10-ohm rheostat. None of these connections create noticeable hum and, therefore, require no filtering of any sort.

The detector bias presents a little difficulty. If we wish to adopt a grid-leak type of detector, the problem is somewhat simplified as far as hum is concerned; for we may return the grid directly to the positive end of the filament. But, as you already know, a grid-leak detector is not capable of the best tone quality, so why compromise? The "C"-bias detector, however, naturally requires a negative bias which must be obtained somewhere.

All ordinary efforts to secure it in the same manner as in the first audio tube were unsuccessful. The filament circuits, though their thermal lag prevents the commutator fluctuations from affecting the plate current, have, nevertheless, these current fluctuations in them. Any attempt to obtain a bias by means of a voltage drop across portions of the filament circuit will result in the commutator hum being present in those voltage sources. In the case of the other bias connections, the magnitude of the commutator ripple is not sufficient to be annoying. The detector bias is the exception which proves the rule. Here the least little ripple is impressed on the very input to the entire audio-amplification train.

An ordinary, small 4 1/2-volt "C" battery seems to be the most economical and satisfactory answer; by the use of this the proper grid bias for the detector is obtained without hum. Such a battery should last for a year or more and may be replaced for a very nominal sum. Any attempt to obtain this bias by a filtering system would be

BASHFUL?

"Shame on you!" Are you nervous, embarrassed in company of the other sex? Stop being shy of strangers. Conquer the terrible fear of your superiors. Be cheerful and confident of your future! Your faults easily overcome so you can enjoy life to the fullest. Send 25c. for this amazing book.

RICHARD BLACKSTONE
BR-5 Flatiron Bldg., New York

PATENTS Write for Free Guide Book, "HOW TO OBTAIN A PATENT" and Record of Invention Blank. Send model or sketch and description of your invention for our Inspection and Advice Free. RADIO and ELECTRICAL Cases a Specialty. EASY PAYMENTS in INSTALLMENTS. VICTOR J. EVANS & CO., 923-9th, Washington, D. C.

If you are a service man, professional or radio-trician, you should receive RADIO-CRAFT each month. Turn to page 410 of this issue and read the special offer to those who are actively engaged in radio.

comparatively prohibitive in cost. The various "C" bias circuits are shown in Figs. 4 and 5.

Design of the Receiver

The complete over all circuit is shown in Fig. 6. One or two features exist here which require some explanation; for instance, it is very essential that a separate ground be employed for the aerial circuit. Any attempt to use the power line as a ground, or to ground the power line, will result in decreased reception or elaborate fireworks. Then again, the modern tendency is toward a decreased number of tuning dials. We do not recommend the ganging of all three tuning circuits; but the second and third tuned circuits may be combined into one control, if a large condenser is inserted between the coil and the tuning condenser as shown in the grid circuit of the detector; one is shown in the plate of the detector, where it acts as a blocking condenser to separate audio currents from the rectified radio-frequency currents. Another by-pass condenser is connected across the potentiometer regulating the voltage on the plates of the R.F. tubes. Still a third will be found across the 10-ohm rheostat; but this is not so essential.

There is a general impression that the direct-current user is more or less out of luck—that good radio reception cannot be obtained with the voltages he has available. This is erroneous. You will admit that all of the tubes, with the exception of the power stage, are supplied with even more than the standard 90 volts used in battery-operated sets. The radio-frequency stages have actually as high as 110 volts on the plates. It then remains to consider only the last push-pull circuit, and the main consideration in obtaining undistorted output from this stage is the amount of "C"-bias which may be applied to permit a strong signal on the grid without running the grid positive. The push-pull connection immediately cuts the grid swing in half, and the use of the 71A tubes enables us to use a 15-volt bias with the low plate voltage at hand. Thus, a maximum signal grid swing of 30 volts may be obtained, under the conditions outlined. This grid swing is almost as great as that permitted by the use of a straight 71A tube operated with 180 volts on the plates.

All in all, considering the entire cost of the set with its associated power equipment, this direct-current receiver is by far the most inexpensive set yet designed. It is far cheaper than a battery set and, of course, costs much less than an A.C. receiver. In addition, it consumes only about 60 watts of energy, and thus costs only about a half a cent an hour to operate. Can you beat it?

Craftsmen's Letters

(Continued from page 398)

16.80 meters, gives a very poor signal here at all times. VK2ME has a very good loud-speaker signal here, usually.

FRED EASTER,
3353 Southside Ave.,
Cincinnati, Ohio.

FROM A CUBAN STATION

Editor, RADIO-CRAFT:

We broadcast daily from 3 p.m. to 10 p.m.; 292 meters, 1027 kc., 100 watts. We shall be glad to receive reports.

MANUEL and GUILLERMO SALAS,
Station 2MG,
San Rafael 14, Havana, Cuba.

Open Forum

(Continued from page 374)

sets were introduced; proving that the A. C. tube is not alone at fault.

In the battery-set calls, usually the battery suffered criticism; and many times by habit rather than fact.

If the Service Man would actually service the set, inspect the ground connection, the aerial, and the wire connections within the set, etc., he would improve the efficiency and leave a happy customer who would again call him for such service as might be required, and for a new set or new tubes when needed.

The average Service Man will blame 85% of his calls to tubes. I claim this is unfair to the radio tube industry, and not the proper manner in which it should secure business.

The Service Man can be a benefactor—but is he?

L. P. NAYLOR,
Arcturus Radio Tube Co.,
260 Sherman Ave., Newark, N. J.

"SOUND" MOVIE INSTALLATION SAVES LIVES

SERVICE Men do not always realize the responsibility which may rest on their shoulders at unexpected times. It was the perfectly-functioning audio amplifier of the Movietone "talkie" unit at the Morton Theater, Dorchester, Mass., which recently enabled the theater manager to address 2,000 patrons who had been alarmed by a false "fire" alarm; preventing a panic.

Opportunities for Service

(Continued from page 374)

(Opportunity 1) Service Man, several years' experience, desires place with manufacturer of a good set, to study the line thoroughly and have opportunity for advancement. Salary to begin less important. Age 36, single, Protestant. (Suburb of New York City.)

(Opportunity 2) Naval electrician, for twelve years in charge of radio equipment afloat and ashore, who has done civilian service work while stationed in port, will be discharged from the service in June. Desires a position devoted to electrical and radio maintenance work, especially in hotel or large apartment. Married. (Now stationed in southeast.)

(Opportunity 3) Radio Dealer considers closing out own business, later on, to secure employment as service manager, or in line of promotion to that position, with large company. (Iowa.)

(Opportunity 4) Service Man for a company having a chain of eight stores, experienced in transmitting, public-address and theatre systems (is a musician) will consider proposition which will justify change. Age 23. (Central Pennsylvania.)

(Opportunity 5) Service Man now connected with wholesale radio distributors, who has had experience with testing equipment, would like to make connection affording experience of Movietone work. (Washington, D. C.)

(Opportunity 6) Service Man, three years' experience, student, draftsman, in business for self, will consider opening with progressive electrical firm. Age 18. (Montana.)

(Opportunity 7) Service Man, in business; two years' mechanical engineering; seven years' automobile parts dept. manager, will go anywhere conditions are right. Age 46. (Michigan.)

(Opportunity 8) Service Man, five years' experience; light and power electrician, automobile mechanic, speaks German. Will consider any proposition affording advancement. Age 28. Married. (Wisconsin.)

(Opportunity 9) Service Man, six years' experience, seeks position as radiotrician. (New York State.)

(Opportunity 10) Service Man, specializing in power packs, jobbing condensers, is interested in purchasing good resistors and transformers at better prices. (Illinois.)

2 Testers you need
at a price you can afford



Ratest Pocket Oscillator \$7.50

Simple and handy as a flashlight. A combined high and low frequency generator and continuity tester; furnishes signal for synchronizing and neutralizing and for final checking; tests audio frequency amplifier; checks small and large condensers; can be used as code test. A marvelously efficient, compact radio trouble shooter that speeds up your work.

Ratest Handy Tube Checker \$19.50



Tests Screen Grid

and all other tubes in general use, both A.C. and D.C. Incredibly simple and compact, yet the most efficient tester ever designed. No complicated switches. Separate socket for each voltage, with voltage and normal readings plainly shown. Operates from A.C. line. Anybody can use—practically foolproof. Comes in handsome hardwood case—an ornament to your counter or shop and the best \$19.50 you ever spent for tube service and sales.

Both the Pocket Oscillator and Tube Checker are shipped on 3 days' trial. Purchase price refunded by express agent, if you are not entirely satisfied. You can't lose.

RATEST INSTRUMENTS CO.
350 Supreme Bldg., Greenwood, Miss.

The latest "dope" on Radio

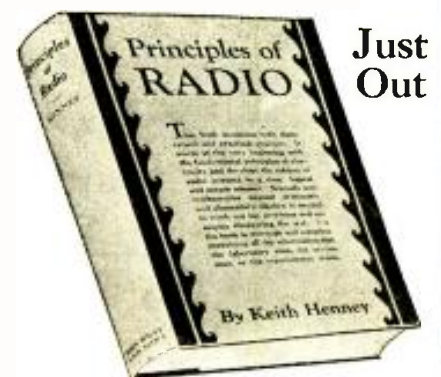

Just Out

Principles of Radio

By KEITH HENNEY

Director of the Laboratory,
Radio Broadcast Magazine

This book combines both practical and theoretical qualities. It treats everything from the Production of Radio currents to their transmission and reception, yet it requires scarcely any knowledge of mathematics beyond arithmetic and elementary algebra.

The author has presented problems, examples and experiments which appear in no other radio book. The illustrations are practical in nature and there are 33 experiments, all of which have been performed in the laboratory of the Radio Broadcast Magazine.

Price, \$3.50

ON APPROVAL COUPON
JOHN WILEY AND SONS, INC.,
440 Fourth Ave., New York City.
Gentlemen: Kindly send me on approval Henney's "Principles of Radio." I agree to remit the price (\$3.50) within ten days after its receipt or return the book postpaid.
Name
Address
Position or Reference..... RC-2-30

PILOT SCREEN-GRID NEW KIT

COVERS 200—600 METERS

Amazes Experts!



Kit No. K-123. Complete kit of parts for Pilot Screen-Grid Receiver, including Walnut-finished metal cabinet, but without Power Pack. *Custom Set-Builders' Price in U. S. A.*

\$29⁷⁵

Kit No. K-122. Complete kit of parts for Pilot Screen-Grid Receiver, including drilled front panel. (Does not include cabinet or Power Pack.) *Custom Set-Builders' Price in U. S. A.*

\$25⁵⁰

Kit No. K-124. Complete kit of parts for Pilot Screen-Grid Receiver, including Walnut-finished cabinet and ABC Power Pack. *Custom Set-Builders' Price in U. S. A.*

\$46²⁵

FEATURES OF THE PILOT SCREEN-GRID KIT

Embodies Push-pull audio and all latest refinements of high-priced screen-grid receivers.

Two screen-grid amplifiers fully shielded (7 tubes including rectifier).

So sensitive it operates perfectly on a 10-foot indoor aerial—no outside antenna required.

Highly selective—razor-edge tuning.

Very simple to assemble and wire. Removable bottom on cabinet permits easy access.

Operated by practically all 171-A power packs.



USE PILOTRON RADIO TUBES, "endorsed by professionals," for these RECEIVERS—and wherever EXCEPTIONAL RESULTS are REQUIRED!

BECAUSE we make Pilotrons ourselves—and are SURE of their quality.

BECAUSE Pilot's Screen-Grid and Short-wave Receivers were engineered to make FULL USE of the superior quality built into Pilotrons!

When the A. C. Super-Wasp demanded the development of a tube to meet the exacting requirements of A.C. Short-wave work, Pilotron P-227 was the result—an outstandingly superior tube for broadcast receivers!

SHORT WAVE For A. C. OPERATION

Kit No. K-115. The A. C. Super-Wasp, designed by David Grimes, John Geloso and Robt. S. Kruse, is a 10,000 mile thriller utilizing Screen-grid and specially developed Pilotron 227.

Use your own ABC Power Pack or Pilot K-111 at \$16.50, especially designed for the Super-Wasp. Power Pack Extra.

Custom Set-Builders' Price in U. S. A.

\$34⁵⁰

For BATTERY OPERATION

Kit No. K-110. The original Super-Wasp, used all over the world where A.C. is not available. Also preferred by many S.W. fans. *Custom Set-Builders' Price in U. S. A.*

\$29⁵⁰

PILOT RADIO & TUBE CORP.

RETURN THIS COUPON

RADIO INTERNATIONAL GUILD

103 Broadway, Brooklyn, New York

Enroll me as member of Radio International Guild, sending membership pin, certificate, card, and current issue of "Radio Design," the Guild's official organ (also 3 additional quarterly issues). I enclose 50c, coin or stamps, to pay for everything for one entire year.

Name [Please write or print plainly]

Address

City State.....

WORLD'S LARGEST
RADIO PARTS PLANT
ESTABLISHED 1908

323 BERRY STREET
BROOKLYN, N. Y.
U. S. A.